

TC22/TC27

Touch Computer



ZEBRA

Product Reference Guide

2024/12/17

ZEBRA and the stylized Zebra head are trademarks of Zebra Technologies Corporation, registered in many jurisdictions worldwide. All other trademarks are the property of their respective owners. ©2024 Zebra Technologies Corporation and/or its affiliates. All rights reserved.

Information in this document is subject to change without notice. The software described in this document is furnished under a license agreement or nondisclosure agreement. The software may be used or copied only in accordance with the terms of those agreements.

For further information regarding legal and proprietary statements, please go to:

SOFTWARE: zebra.com/informationpolicy.

COPYRIGHTS: zebra.com/copyright.

PATENTS: ip.zebra.com.

WARRANTY: zebra.com/warranty.

END USER LICENSE AGREEMENT: zebra.com/eula.

Terms of Use

Proprietary Statement

This manual contains proprietary information of Zebra Technologies Corporation and its subsidiaries ("Zebra Technologies"). It is intended solely for the information and use of parties operating and maintaining the equipment described herein. Such proprietary information may not be used, reproduced, or disclosed to any other parties for any other purpose without the express, written permission of Zebra Technologies.

Product Improvements

Continuous improvement of products is a policy of Zebra Technologies. All specifications and designs are subject to change without notice.

Liability Disclaimer

Zebra Technologies takes steps to ensure that its published Engineering specifications and manuals are correct; however, errors do occur. Zebra Technologies reserves the right to correct any such errors and disclaims liability resulting therefrom.

Limitation of Liability

In no event shall Zebra Technologies or anyone else involved in the creation, production, or delivery of the accompanying product (including hardware and software) be liable for any damages whatsoever (including, without limitation, consequential damages including loss of business profits, business interruption, or loss of business information) arising out of the use of, the results of use of, or inability to use such product, even if Zebra Technologies has been advised of the possibility of such damages. Some jurisdictions do not allow the exclusion or limitation of incidental or consequential damages, so the above limitation or exclusion may not apply to you.

Contents

About This Guide.....	13
Mobility DNA Enterprise License.....	13
Licensed Features.....	13
Core OS, Apps, and mDNA.....	13
Fusion.....	14
Connectivity.....	14
Request Licenses.....	15
Notational Conventions.....	15
Icon Conventions.....	15
Service Information.....	16
Determining Software Versions.....	16
Determining Serial Number.....	17
Getting Started.....	18
Unpacking.....	18
Features.....	19
Setting Up the Device.....	21
Installing a microSD Card.....	21
Installing the SIM Card.....	22
Installing the Battery.....	23
Using the Rechargeable Li-Ion Battery with BLE Beacon.....	24
Main Battery Charging.....	24
Replacing the SIM Card.....	25
Replacing the microSD Card.....	26
Replacing the Battery.....	27

Using the Device.....	31
Home Screen.....	31
Setting Home Screen Rotation.....	33
Status Bar.....	33
Status Icons.....	33
Notification Icons.....	35
Managing Notifications.....	37
Opening the Quick Access Panel.....	38
Quick Access Panel Icons.....	38
Editing Icons on the Quick Settings Bar.....	41
Battery Management.....	41
Low Battery Notification.....	41
Turning Off the Radios.....	41
Checking Battery Status.....	42
Monitoring Battery Usage.....	42
Interactive Sensor Technology.....	42
Waking the Device.....	43
USB Communication.....	43
Transferring Files.....	43
Transferring Photos.....	44
Disconnecting from the Host Computer.....	44
Settings.....	45
Accessing Settings.....	45
Display Settings.....	45
Setting the Screen Brightness Automatically.....	45
Setting the Screen Brightness Manually.....	45
Setting Night Light.....	46
Setting Screen Rotation.....	46
Setting Lock Screen Notifications.....	46
Setting Display and Text Size.....	46
Notification LED Brightness Level.....	47
Setting Touch Panel Mode.....	47
Setting the Date and Time.....	47

General Sound Setting.....	48
Sound Options.....	48
Setting Wake-Up Sources.....	48
Remapping a Button.....	49
Remapping Keys.....	50
Alert Button.....	50
Configure the Alert Button.....	50
Alert Accessibility Service.....	51
Using an Alert Button.....	51
Keyboards.....	51
Enabling Keyboards.....	51
Switching Between Keyboards.....	51
Using the Android and Gboard Keyboards.....	52
Edit Text.....	52
Entering Numbers, Symbols, and Special Characters.....	52
Enterprise Keyboard.....	52
Numeric Tab.....	53
Alpha Tab.....	53
Additional Character Tab.....	53
Scan Tab.....	53
Language Usage.....	53
Changing the Language Setting.....	53
Adding Words to the Dictionary.....	53
Notifications.....	54
Enabling Blink Light.....	54
Applications.....	55
Installed Applications.....	55
Accessing Apps.....	56
Switching Between Recent Apps.....	56
Battery Manager.....	56
Opening Battery Manager.....	56
Battery Manager Information.....	57
Camera.....	58

Taking Photos.....	58
Recording Videos.....	60
Camera Settings.....	61
DataWedge.....	62
DWDemo Icons.....	63
Selecting a Scanner.....	63
RxLogger.....	64
RxLogger Configuration.....	64
Configuration File.....	64
Enabling Logging.....	64
Disabling Logging.....	65
Extracting Log Files.....	65
Backing Up Data.....	65
RxLogger Utility.....	65
Data Capture.....	67
Imaging.....	67
Digital Camera.....	68
Operational Modes.....	68
Scanning Considerations.....	69
Scanning with Internal Imager.....	69
Scanning with the Camera.....	71
Scanning with the RS507/RS507X Hands-Free Imager.....	72
Scanning with the RS5100 Ring Scanner.....	75
Scanning with the RS6000 Bluetooth Ring Scanner.....	76
Scanning with the RS6100 Bluetooth Ring Scanner.....	79
Scanning with the LI3678 Linear Imager.....	81
Scanning with the LI3608 Linear Scanner.....	82
Scanning with the DS8178 Digital Scanner.....	84
Scanning with the DS3678 Bluetooth Scanner.....	85
Scanning with the DS3608 USB Scanner.....	87
Scanning with the DS2278 Digital Scanner.....	88
Pairing a Bluetooth Ring Scanner.....	89
Pairing in SSI Mode Using Near Field Communication.....	89

Pairing in HID Mode Using Near Field Communication.....	89
Pairing Using Simple Serial Interface (SSI).....	90
Pairing Using Bluetooth Human Interface Device.....	90
Pairing a Bluetooth Scanner.....	91
Pairing Using Simple Serial Interface.....	91
Pairing Using Bluetooth Human Interface Device.....	92
DataWedge.....	93
Enabling DataWedge.....	93
Disabling DataWedge.....	93
Supported Decoders.....	94
Camera Supported Decoders.....	94
SE4710 Internal Imager Supported Decoders.....	94
SE55 Internal Imager Supported Decoders.....	95
RS507/RS507x Supported Decoders.....	96
RS5100 Supported Decoders.....	97
RS6000 Supported Decoders.....	98
RS6100 Supported Decoders.....	98
LI3678 Supported Decoders.....	99
DS8178 Supported Decoders.....	100
DS3678 Supported Decoders.....	101
DS3608 Supported Decoders.....	102
DS2278 Supported Decoders.....	102
Wireless.....	104
Wireless Wide Area Networks.....	104
Sharing the Mobile Data Connection.....	104
Data Usage.....	106
Cellular Network Settings.....	108
Wireless Local Area Networks.....	110
Connecting to a Wi-Fi Network.....	110
Wi-Fi Version.....	110
Removing a Wi-Fi Network.....	111
WLAN Configuration.....	111
Bluetooth.....	116

Adaptive Frequency Hopping.....	116
Security.....	116
Bluetooth Profiles.....	117
Bluetooth Power States.....	118
Bluetooth Radio Power.....	118
Discovering Bluetooth Device(s).....	119
Changing the Device's Bluetooth Name.....	119
Connecting to a Bluetooth Device.....	119
Selecting Profiles on the Bluetooth Device.....	120
Unpairing a Bluetooth Device.....	120
Cast.....	120
Near Field Communications.....	120
Reading NFC Cards.....	121
Enterprise NFC Settings.....	121
Calls.....	123
Emergency Calling.....	123
Audio Modes.....	123
Bluetooth Headset.....	123
Adjusting Audio Volume.....	124
Making a Call Using the Dialer.....	124
Accessing Dialing Options.....	124
Make a Call Using Contacts.....	125
Using the Dialer.....	125
Using the Contacts App.....	125
Make a Call Using Call History.....	125
Using the Call History List.....	126
Making a Conference Call on GSM.....	126
Making a Call Using a Bluetooth Headset.....	127
Answering Calls.....	127
Call Settings.....	128
Accessories.....	131

Main Battery Charging.....	134
Spare Battery Charging.....	135
Charging Temperature.....	135
1-Slot Charge Only Cradle.....	135
Setup.....	137
Charging the Device.....	138
1-Slot USB Cradle.....	138
Setup.....	139
Charging the Device.....	140
Ethernet Communication.....	140
1-Slot Charge Only with Spare Battery Cradle.....	142
Setup.....	143
Charging the Device.....	144
4-Slot Battery Charger.....	144
Setup.....	145
Two Charger Setup.....	146
Charging Spare Batteries.....	147
5-Slot Charge Only Cradle.....	147
Setup.....	149
Charging the Device.....	150
5-Slot Ethernet Cradle.....	150
Setup.....	152
Daisy-chaining Ethernet Cradles.....	152
Ethernet Communication.....	153
Charging the Device.....	155
USB Cable.....	156
USB Communication.....	156
Charging the Device.....	156
Handstrap.....	157
Attaching the Handstrap.....	158
Trigger Handle.....	159
Installing the Optional Lanyard.....	159
Inserting the Device into the Trigger Handle.....	160
Removing the Device from the Trigger Handle.....	161

5-Slot Cradle Rack Installation.....	162
Installing the 5-Slot Cradle on a Rack.....	162
4-Slot Battery Chargers Rack Installation.....	165
Installing 4-Slot Battery Chargers on a Rack.....	165
Installing the Rack Mount.....	168
Wall Installation.....	171
Bottom Tray Assembly.....	172
Mounting the Bracket.....	172
Application Deployment.....	174
Android Security.....	174
Secure Certificates.....	174
Installing a Secure Certificate.....	174
Configuring Credential Storage Settings.....	175
Android Development Tools.....	175
Android Development Workstation.....	175
Enabling Developer Options.....	175
EMDK for Android.....	176
StageNow for Android.....	176
GMS Restricted.....	176
ADB USB Setup.....	177
Enabling USB Debugging.....	177
Entering Android Recovery Manually.....	178
Application Installation Methods.....	178
Installing Applications Using the USB Connection.....	178
Installing Applications Using the Android Debug Bridge.....	179
Installing Applications Using Wireless ADB.....	179
Installing Applications Using a microSD Card.....	180
Uninstalling an Application.....	181
Android System Update.....	182
Performing a System Update Using a microSD Card.....	182
Performing a System Update Using ADB.....	182
Verifying System Update Installation.....	183
Android Enterprise Reset.....	183

Performing an Enterprise Reset From Device Settings.....	183
Performing an Enterprise Reset Using microSD Card.....	184
Performing an Enterprise Reset Using ADB.....	184
Android Factory Reset.....	185
Performing a Factory Reset Using microSD Card.....	185
Performing a Factory Reset Using ADB.....	185
Android Storage.....	186
Random Access Memory.....	186
Viewing Memory.....	187
Internal Storage.....	187
External Storage.....	187
Managing Apps.....	188
App Details.....	188
Managing Downloads.....	189
Maintenance and Troubleshooting.....	190
Maintaining the Device.....	190
Battery Safety Guidelines.....	191
Best Practices for Enterprise Mobile Computing Devices Operating in Hot Environments and Direct Sunlight.....	191
Properly Plugging and Unplugging a USB-C Cable.....	192
Connecting a USB-C Cable.....	192
Disconnecting a USB-C Cable.....	193
Cleaning Instructions.....	193
Approved Cleanser Active Ingredients.....	194
Harmful Ingredients.....	194
Device Cleaning Instructions.....	194
Special Cleaning Notes.....	194
Cleaning Materials Required.....	195
Cleaning Frequency.....	195
Cleaning the Device.....	195
Housing.....	195
Display.....	195
Camera and Exit Window.....	195

Cleaning Battery Connectors.....	196
Cleaning Cradle Connectors.....	196
Troubleshooting.....	196
Resetting the Device.....	197
Troubleshooting the Device.....	197
1-Slot Charge Only Cradle Troubleshooting.....	200
1-Slot USB Cradle Troubleshooting.....	200
1-Slot Cradle with Spare Battery Slot.....	201
5-Slot Charge Only Cradle Troubleshooting.....	201
5-Slot Ethernet Cradle Troubleshooting.....	202
4-Slot Battery Charger Troubleshooting.....	203
Technical Specifications.....	204
SE4710 Decode Distances.....	204
SE55 Decode Distances.....	205
1-Slot Charge Only Cradle Specifications.....	206
1-Slot USB Cradle Specifications.....	206
1-Slot Charge Only with Battery Cradle Specifications.....	207
5-Slot Charge Only Cradle Specifications.....	207
5-Slot Ethernet Cradle Specifications.....	208
4-Slot Battery Charger Specifications.....	209
Trigger Handle Specifications.....	209

About This Guide

This guide provides information about setting up and using TC22/TC27 touch computers with the Android™ operating system. Some screens shown in this guide may differ from the actual screens shown on the device.

Mobility DNA Enterprise License

Powerful complimentary Mobility DNA tools are made available and ready to use, making it easier to stage, secure, and troubleshoot the TC22/TC27; capture and send data to your applications right out of the box; restrict access to features and applications; and more. The Mobility DNA Enterprise License delivers premium voice capabilities over Wi-Fi and unlocks powerful tools and utilities that take workforce productivity and device management simplicity to a new level.

VoLTE delivers superior voice quality over cellular networks, while Zebra's advanced VoWiFi technology, included with the Mobility DNA Enterprise License, delivers superior voice quality over all of your WiFi voice applications. For example, Push-to-Talk Express for basic walkie-talkie style communications, the Workforce Connect PTT Pro subscription service for walkie talkie-style communications over cellular and WiFi networks, and Workforce Connect Voice to turn the devices into fully-featured PBX handsets.

Licensed Features

Licensed features are only available on this device with the purchase of a Mobility DNA Enterprise License. A single license unlocks all premium features on the device. Some apps may require a download from zebra.com/support. Please contact your administrator or go to zebra.com for more information.



NOTE: Android Multi-User Mode is not supported by the Mobility DNA Enterprise License. Entering Multi-User Mode on a device with an active Mobility DNA Enterprise License may cause undefined behavior.

Core OS, Apps, and mDNA

Core OS, apps, and mDNA features that require the purchase of a Mobility DNA Enterprise License.

- PowerPrecision Console
- Zebra Volume Control
- Secure NFC through EMDK
- Firmware Over the Air (FOTA)
- Device Tracker

- Enterprise Keyboard
- Device Central
- NG SimulScan through EMDK and DataWedge
- WFC Voice

Fusion

Fusion features that require the purchase of a Mobility DNA Enterprise License.

- Power Management (WMM U-APSD)
- EAP Methods (LEAP)
- PEAP Phase 2: GTC Dynamic Password
- Fast Roam (CCKM)
- CCXv4 (compliant, but not certified)
- Band Preference (5 GHz Only)
- Subnet Roam
- 802.11v
- Fusion Logger
- Fusion Status
- Wireless Analyzer
- Wi-Fi Manager (Wi-Fi)
 - Channel mask
 - AutoTimeConfig
 - CCKM
 - WLANPowerSave (WMM-PS)
 - EnableRestrictedSettingsUI
 - BandPreference
 - SubNetRoam
 - PasswordProtectEncryption
 - 802.11v
 - CallAdmissionControl
 - Gratuitous ARP
 - Profile configuration (Dynamic GTC)
 - Profile configuration (LEAP)

Connectivity

Connectivity features that require the purchase of a Mobility DNA Enterprise License.

- Bluetooth Silent Pairing, Trusted and Single Pairing

- Bluetooth NFC Tap and Pair
- Bluetooth CSPs
- Disable future pairing with remote Bluetooth devices.
- Do not allow the device to be visible to other devices over Bluetooth.
- Allow Silent Pairing
- SmartLeash (Quality monitoring feature)
- Clear All PDL (Paired Device List)

Request Licenses

Customers, partners, and distributors require a Mobility DNA Enterprise License. Please request an evaluation or trial license through your account manager.

An account manager or sales engineer can request a trial or evaluation of the Mobility DNA Enterprise License for customers, partners, or distributors using [SFDC forms](#).

Zebra engineering can submit a request for a trial or evaluation of the Mobility DNA Enterprise License using [Service NOW](#).

Notational Conventions

The following notational conventions make the content of this document easy to navigate.

- **Bold** text is used to highlight the following:
 - Dialog box, window, and screen names
 - Dropdown list and list box names
 - Checkbox and radio button names
 - Icons on a screen
 - Key names on a keypad
 - Button names on a screen
- Bullets (•) indicate:
 - Action items
 - List of alternatives
 - Lists of required steps that are not necessarily sequential.
- Sequential lists (for example, those that describe step-by-step procedures) appear as numbered lists.

Icon Conventions

The documentation set is designed to give the reader more visual clues. The following visual indicators are used throughout the documentation set.



NOTE: The text here indicates information that is supplemental for the user to know and that is not required to complete a task.



IMPORTANT: The text here indicates information that is important for the user to know.



CAUTION: If the precaution is not heeded, the user could receive a minor or moderate injury.



WARNING: If danger is not avoided, the user CAN be seriously injured or killed.



DANGER: If danger is not avoided, the user WILL be seriously injured or killed.

Service Information

If you have a problem with your equipment, contact Zebra Global Customer Support for your region. Contact information is available at: zebra.com/support.

When contacting support, please have the following information available:

- Serial number of the unit
- Model number or product name
- Software type and version number

Zebra responds to calls by email, telephone, or fax within the time limits set forth in support agreements.

If your problem cannot be solved by Zebra Customer Support, you may need to return your equipment for servicing and will be given specific directions. Zebra is not responsible for any damages incurred during shipment if the approved shipping container is not used. Shipping the units improperly can possibly void the warranty.

If you purchased your Zebra business product from a Zebra business partner, contact that business partner for support.

Determining Software Versions

Before contacting Customer Support, determine the current software version on your device.

1. Swipe down from the Status bar with two fingers to open the Quick Access panel, and then touch .
2. Touch **About phone**.

3. Scroll to view the following information:

- Status
- Battery information
- Emergency information
- SW components
- Legal information
- Model & hardware
- Model
- Android version
 - Android security patch level
 - Android security patch version
 - Google Play system update
 - Baseband version
 - Kernel version
 - Build Fingerprint
 - Build number
 - Android Security Update

To determine the device International Mobile Equipment Identity (IMEI) information (WWAN only), touch **About phone > IMEI**.

- **IMEI** - Displays the IMEI number for the device.
- **IMEI SV** - Displays the IMEI software version (SV) number for the device.

Determining Serial Number

Before contacting Customer Support, determine the serial number of your device.

- 1.** Swipe down from the Status bar with two fingers to open the Quick Access panel, and then touch .
- 2.** Touch **About phone**.
- 3.** Touch **Model**.

Getting Started

This section provides information to get the device up and running for the first time.

Unpacking

When you receive the TC22/TC27, ensure that all the items are in the shipping container.

1. Carefully remove all protective material from the device and save the shipping container for later storage and shipping.
2. Verify that the following were received:
 - Touch computer
 - PowerPrecision Lithium-ion battery
 - Regulatory Guide
3. Inspect the equipment for damage. If any equipment is missing or damaged, contact the Global Customer Support Center immediately.
4. Prior to using the device for the first time, remove the protective shipping film that covers the scan window, display, and camera window.

Features

This section lists all the features of the TC22/TC27 .

Figure 1 Front View

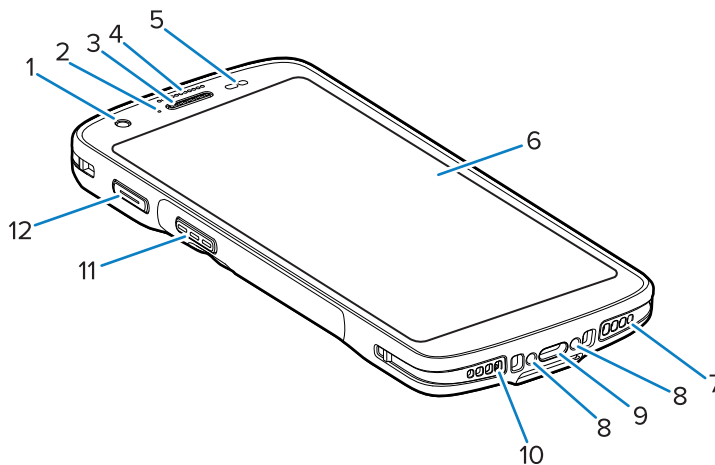

NOTE: Go to [Setting Wake-Up Sources](#) for key mapping details.

Table 1 Front View Features

Number	Item	Description
1	Front Camera	Takes photos and videos (available on some models).
2	Charging/Notification LED	Indicates battery charging status while charging and application-generated notifications.
3	Speaker/Receiver	Use for audio playback in Handset and Speakerphone mode.
4	Data Capture LED	Indicates data capture status.
5	Light/Proximity Sensor	Determines ambient light for controlling display backlight intensity and proximity for turning off the display when in handset mode.
6	Touch Screen	Displays all information needed to operate the device.
7	Speaker	Provides audio output for video and music playback. Provides audio in speakerphone mode.
8	Cradle Charging Contacts	Provides device charging via cradles and accessories.
9	USB-C Connector	Provides USB host, client communications, and device charging via cables and accessories.
10	Microphone	Use for communications in Handset mode.
11	Scan Button	Initiates data capture (programmable).
12	Programmable Button	Typically used for Push-to-Talk communications. Where regulatory restrictions exist ¹ for Push-to-Talk VoIP communication, this button is configurable for use with other applications.

Table 1 Front View Features (Continued)

Number	Item	Description
1	Pakistan, Qatar	

Figure 2 Rear View

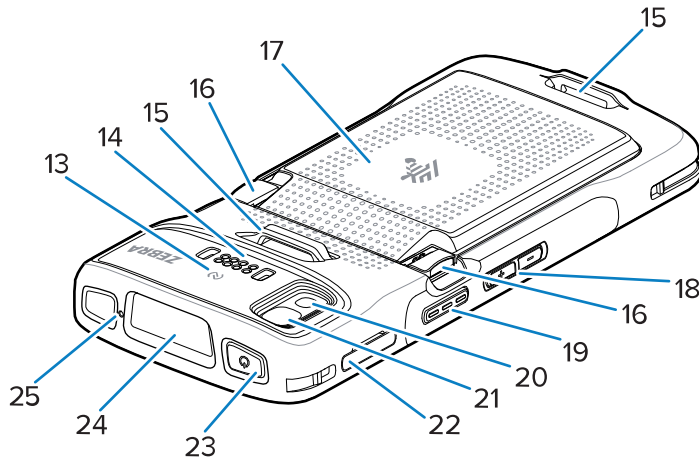

Table 2 Rear View Features

Number	Item	Description
13	NFC Antenna	Provides communication with other NFC-enabled devices.
14	Back common I/O 8 pins	Provides host communications, audio, device charging via cables, and accessories.
15	Basic Hand Strap Mount	Provides mounting point for Basic Hand Strap accessory.
16	Battery Release Latches	Press to remove the battery.
17	PowerPrecision Lithium-ion Battery	Provides power to the device.
18	Volume Up/Down Button	Increase and decrease audio volume (programmable).
19	Scan Button	Initiates data capture (programmable).
20	Camera Flash	Provides illumination for the camera and operates as a flashlight.
21	Rear Camera	Takes photos and videos.
22	Card Holder	Holds a SIM card and an SD card.
23	Power Button	Turns the display on and off. Press and hold to reset the device or power it off.
24	Scanner Exit Window	Provides data capture using the imager.
25	Microphone	Use for communications in Speakerphone mode.

Setting Up the Device

Complete the following to start using the TC22/TC27.

1. Install a micro secure digital (SD) card (optional).
2. Installing a nano SIM card (optional)
3. Install the battery.
4. Charge the device.

Installing a microSD Card

The TC22/TC27 microSD card slot provides secondary non-volatile storage. The slot is located under the battery pack. Refer to the documentation provided with the card for more information, and follow the manufacturer's recommendations for use.



CAUTION: Follow proper electrostatic discharge (ESD) precautions to avoid damaging the microSD card. Proper ESD precautions include, but are not limited to, working on an ESD mat and ensuring that the operator is properly grounded.

1. Pull the card holder out of the device.

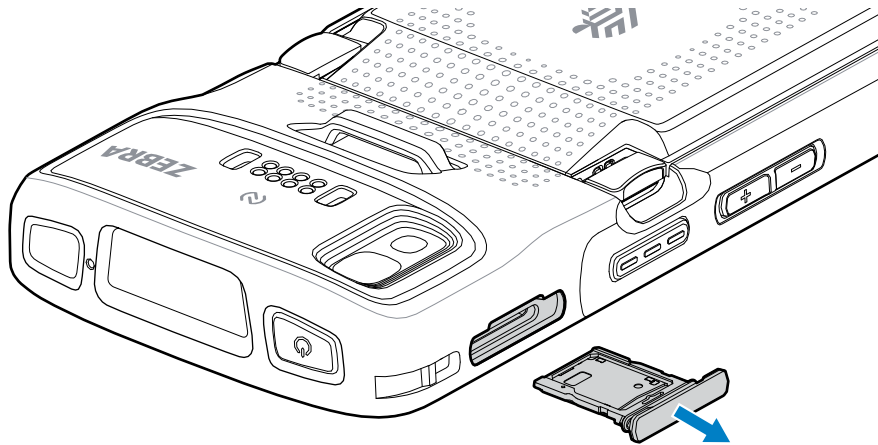

2. Place the microSD card, contact end first, with contacts facing up, into the card holder, then rotate the microSD card down.

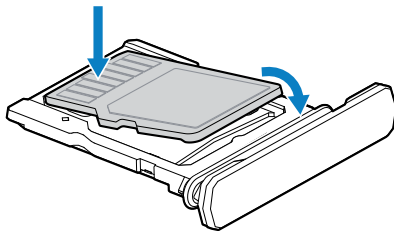

3. Press the card down into the card holder and ensure that it seats properly.

4. Re-install the card holder.

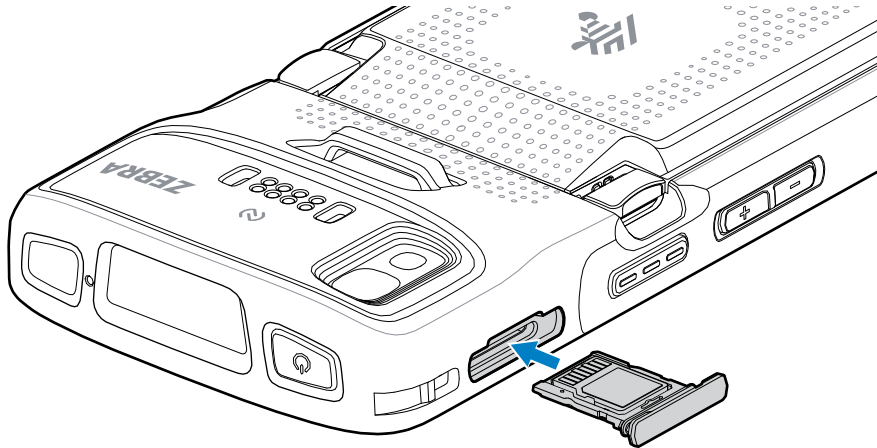

Installing the SIM Card

A SIM Card is required to make calls and transfer data over a cellular network with the TC27.



NOTE: Only use a nano SIM card.



CAUTION: For proper electrostatic discharge (ESD) precautions to avoid damaging the SIM card. Proper ESD precautions include, but not limited to, working on an ESD mat and ensuring that the user is properly grounded.

1. Pull the card holder out of the device.

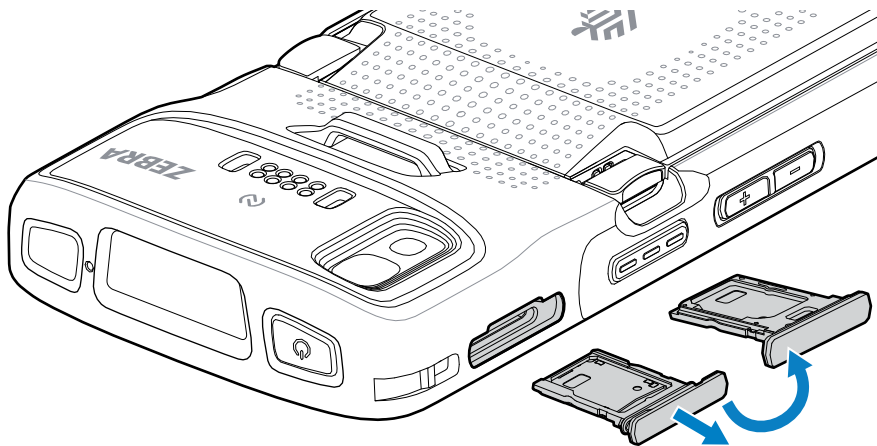

2. Flip the card holder over.

3. Place the SIM card end, with contacts facing up, into the card holder.

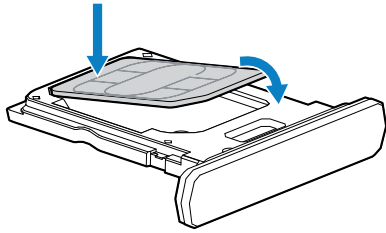

4. Press the SIM card down into the card holder and ensure it seats properly.
5. Flip the card holder over and re-install the card holder.

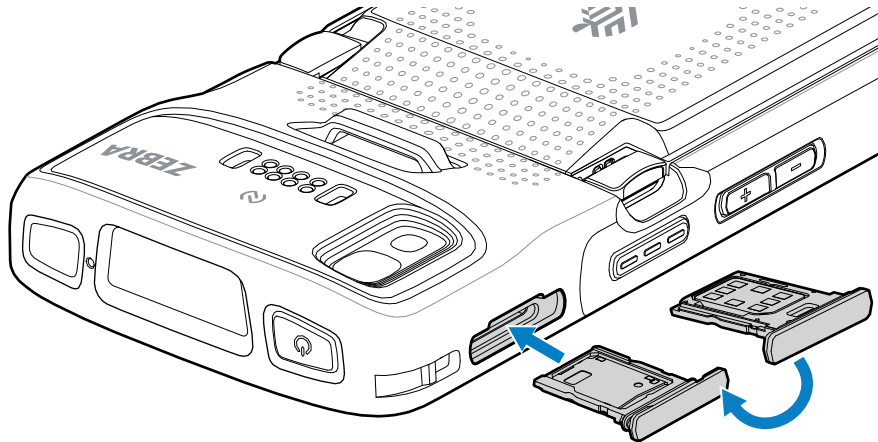

Installing the Battery



NOTE: User modification of the device, particularly in the battery well, such as labels, asset tags, engravings, and stickers, may compromise the intended performance of the device or accessories. Performance levels such as sealing (Ingress Protection (IP)), impact performance (drop and tumble), functionality, and temperature resistance could be affected. **DO NOT** put any labels, asset tags, engravings, or stickers in the battery well.

1. Insert the battery, bottom first, into the battery compartment in the back of the device.

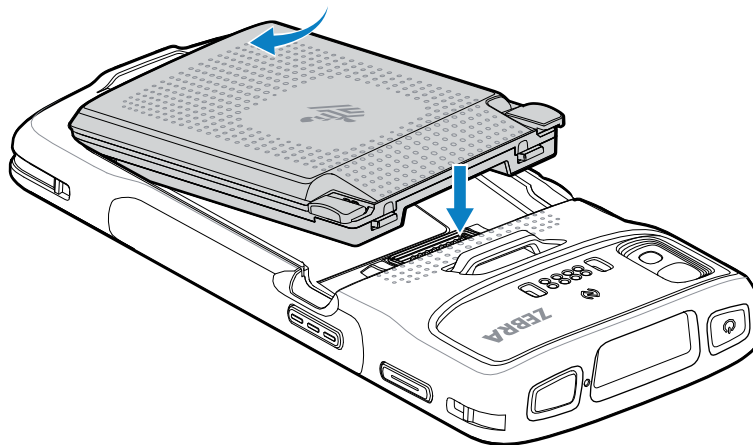

2. Press the battery down into the battery compartment until the battery release latches snap into place.

Using the Rechargeable Li-Ion Battery with BLE Beacon

This device utilizes a rechargeable Li-Ion battery to facilitate BLE Beacon. Once enabled, the battery transmits a BLE signal for up to seven days while the device is powered off due to battery depletion.



NOTE: The device transmits a Bluetooth beacon only when the device is powered off or in Airplane Mode.

For additional information on configuring the Secondary BLE settings, go to techdocs.zebra.com/emdk-for-android/13-0/mx/beaconmgr/.

Main Battery Charging

Before using the device for the first time, charge the main battery until the green Charging/Notification light-emitting diode (LED) remains lit. Use a cable or a cradle with the appropriate power supply to charge the device.

There are three batteries available:

- Standard 3,800 mAh PowerPrecision LI-ON Battery - part number: BTRY-TC2L-2XMAXX-01
- Standard 3,800 mAh PowerPrecision LI-ON Battery with BLE Beacon - part number: BTRY-TC2L-2XMAXB-01
- Extended 5,200 mAh PowerPrecision LI-ON Battery - part number BTRY-TC2L-3XMAXX-01

The device's Charging/Notification LED indicates the battery charging status in the device. The standard battery charges from fully depleted to 80% in less than 1 hour and 20 minutes. The extended battery charges from fully depleted to 80% in less than 1 hour and 50 minutes.



NOTE: Charge batteries at room temperature with the device in Sleep mode.

Table 3 Charging/Notification LED Charging Indicators

State	Indication
Off	The device is not charging. It is incorrectly inserted in the cradle or connected to a power source, and the charger/cradle is not powered.
Slow Blinking Amber (1 blink every 4 seconds)	The device is charging.
Slow Blinking Red (1 blink every 4 seconds)	The device is charging, but the battery is at the end of its useful life.
Solid Green	Charging complete.
Solid Red	Charging is complete, but the battery is at the end of its useful life.
Fast Blinking Amber (2 blinks/second)	Charging error, for example: <ul style="list-style-type: none"> • Temperature is too low or too high. • Charging has gone on too long without completion (typically eight hours).

Table 3 Charging/Notification LED Charging Indicators (Continued)

State	Indication
Fast Blinking Red (2 blinks/second)	<p>Charging error but the battery is at the end of its useful life, for example:</p> <ul style="list-style-type: none"> • Temperature is too low or too high. • Charging has gone on too long without completion (typically eight hours).

Replacing the SIM Card

This section describes how to replace a SIM card (WWAN devices only).



CAUTION—ESD: Follow proper electrostatic discharge (ESD) precautions to avoid damaging the SIM card. Proper ESD precautions include, but are not limited to, working on an ESD mat and ensuring the operator is properly grounded.

1. Press the Power button until the menu displays.
2. Touch **Power Off**.
3. Touch **OK**.
4. Pull the card holder out of the device.

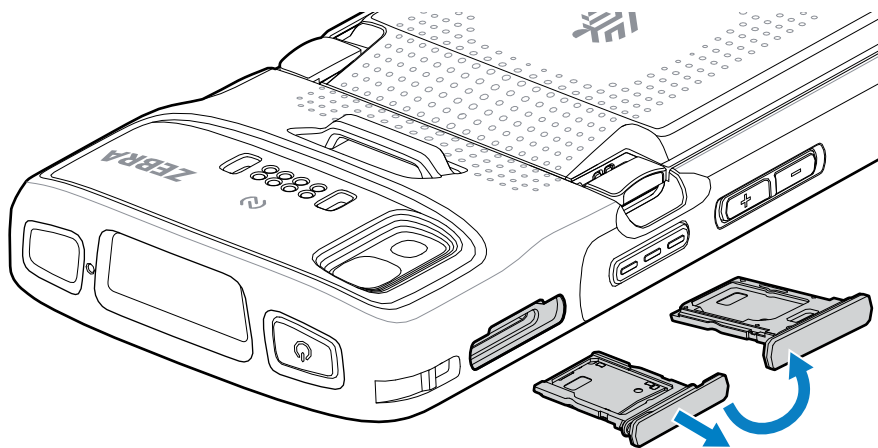

5. Flip the card holder over.
6. Place the SIM card end, with contacts facing up, into the card holder.

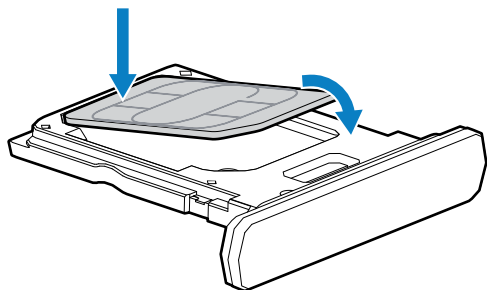

7. Rotate the SIM card down.
8. Press the SIM card down into the card holder and ensure that it seats properly.
9. Flip the card holder over and re-install the card holder.

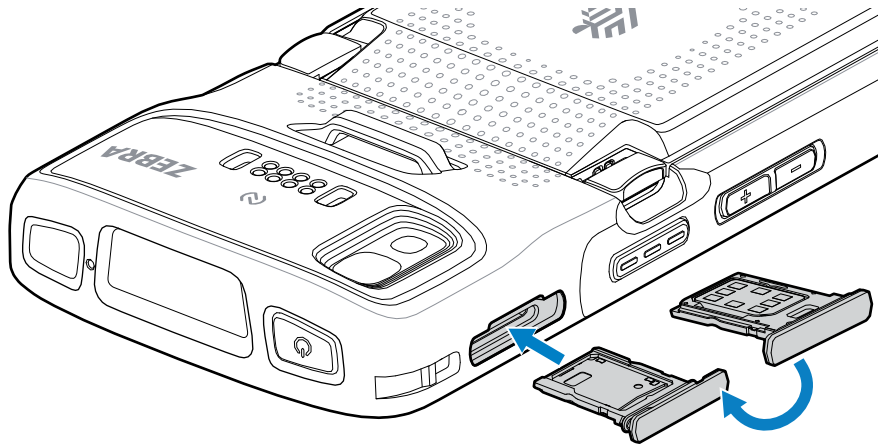

Replacing the microSD Card

Use these procedures to replace a microSD card.

To replace the microSD card:

1. Press the Power button until the menu appears.
2. Touch **Power off**.
3. Touch **OK**.
4. Pull the card holder out of the device.

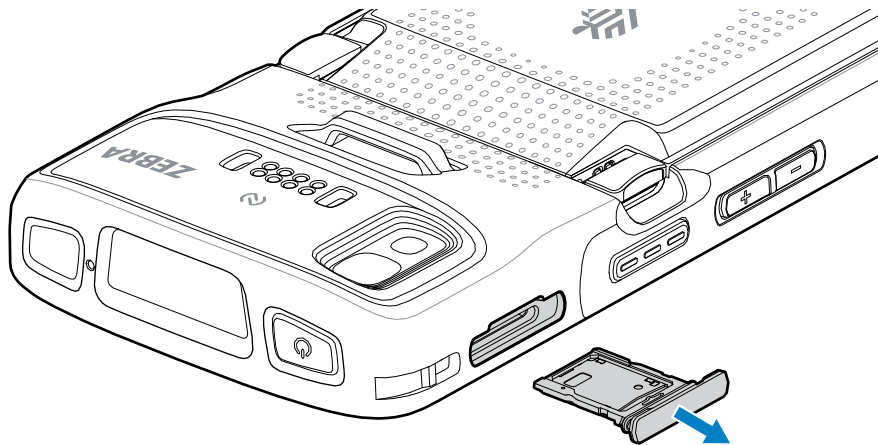

5. Remove the microSD card from the card holder.

6. Place the microSD card, contact end first, with contacts facing up, into the card holder.

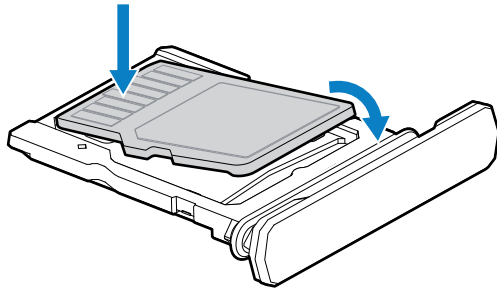

7. Rotate the microSD card down.
8. Press the card down into the card holder and ensure that it seats properly.
9. Re-install the card holder.

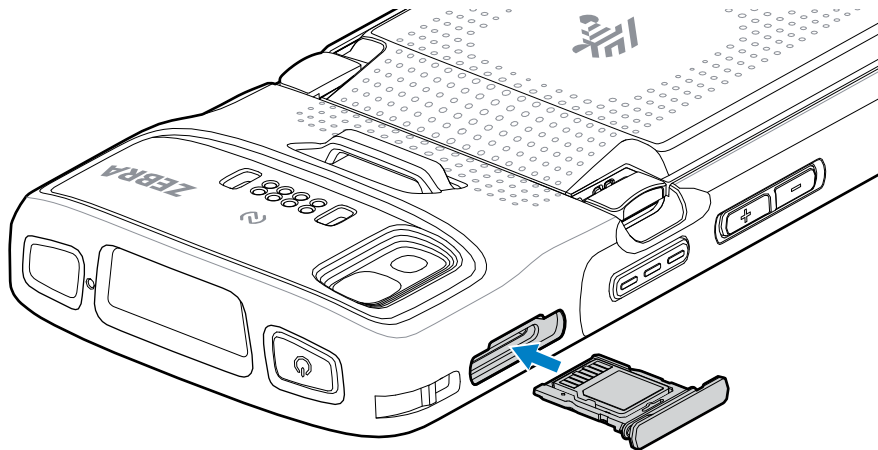

Replacing the Battery

Replacing the battery in the TC22 and TC27 devices.



NOTE: User modification of the device, particularly in the battery well, such as labels, asset tags, engravings, stickers, etc., may compromise the intended performance of the device or accessories. Performance levels such as sealing (Ingress Protection (IP)), impact performance (drop and tumble), functionality, temperature resistance, etc. could be affected. **DO NOT** put any labels, asset tags, engravings, stickers, etc. in the battery well.



CAUTION: Do not add or remove the microSD card during battery replacement.

1. Press the Power button until the menu appears.
2. Touch **Power Off**.
3. If the hand strap is attached, remove the hand strap.

4. Press the two latches down.

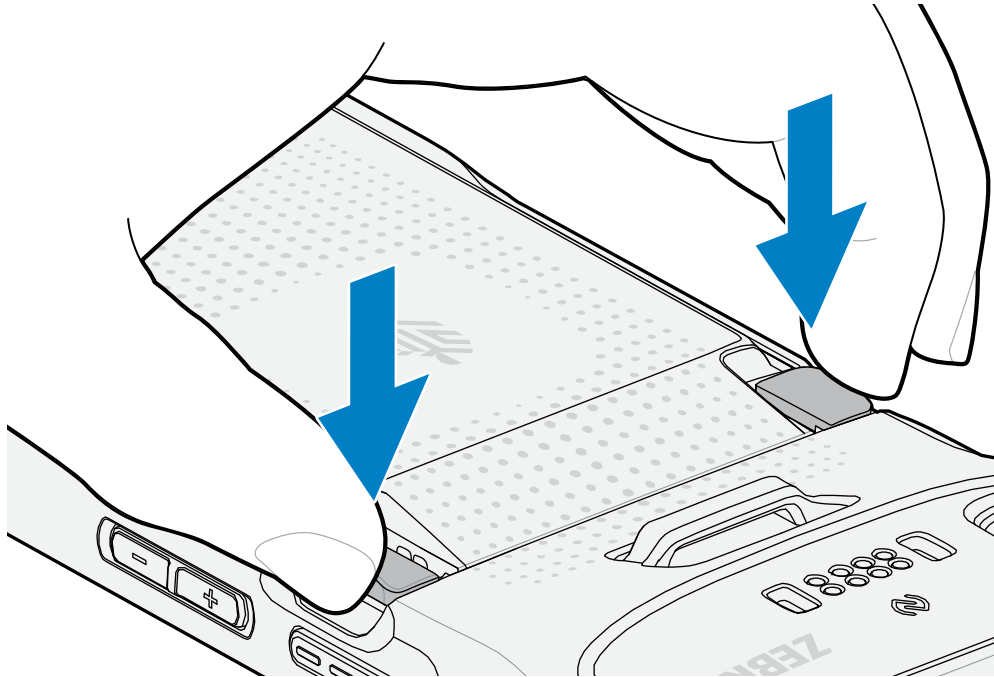

NOTE: Do not attempt to insert fingers under the latches when pulling on the battery. Damage to the latches may occur.

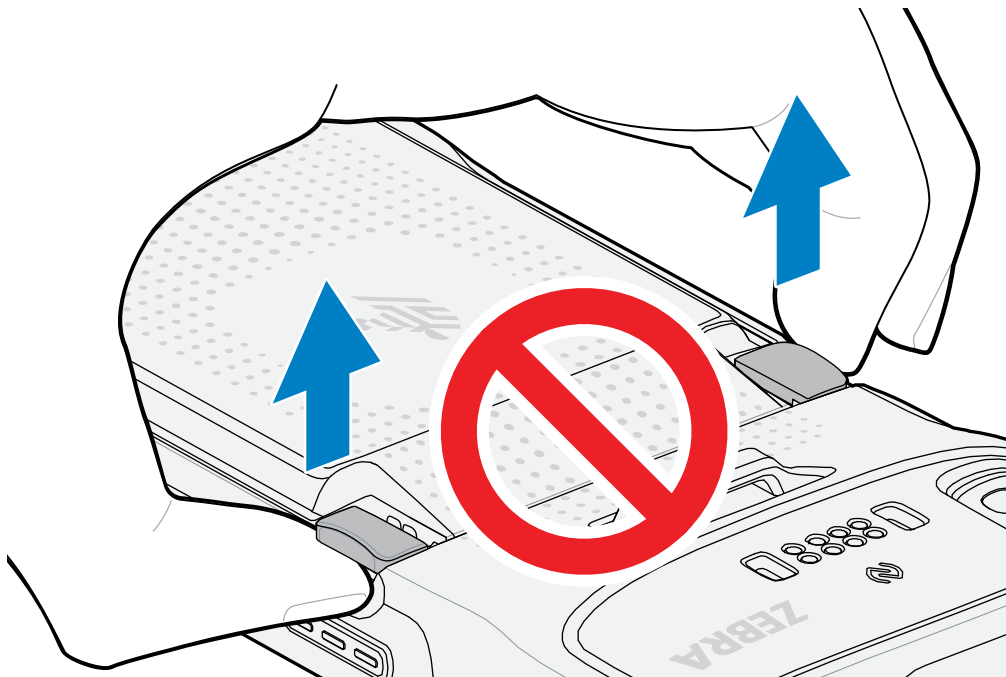

5. While pressing the latches down, press the two latches in toward the center of the device. The latches must be pressed in completely to release the battery.

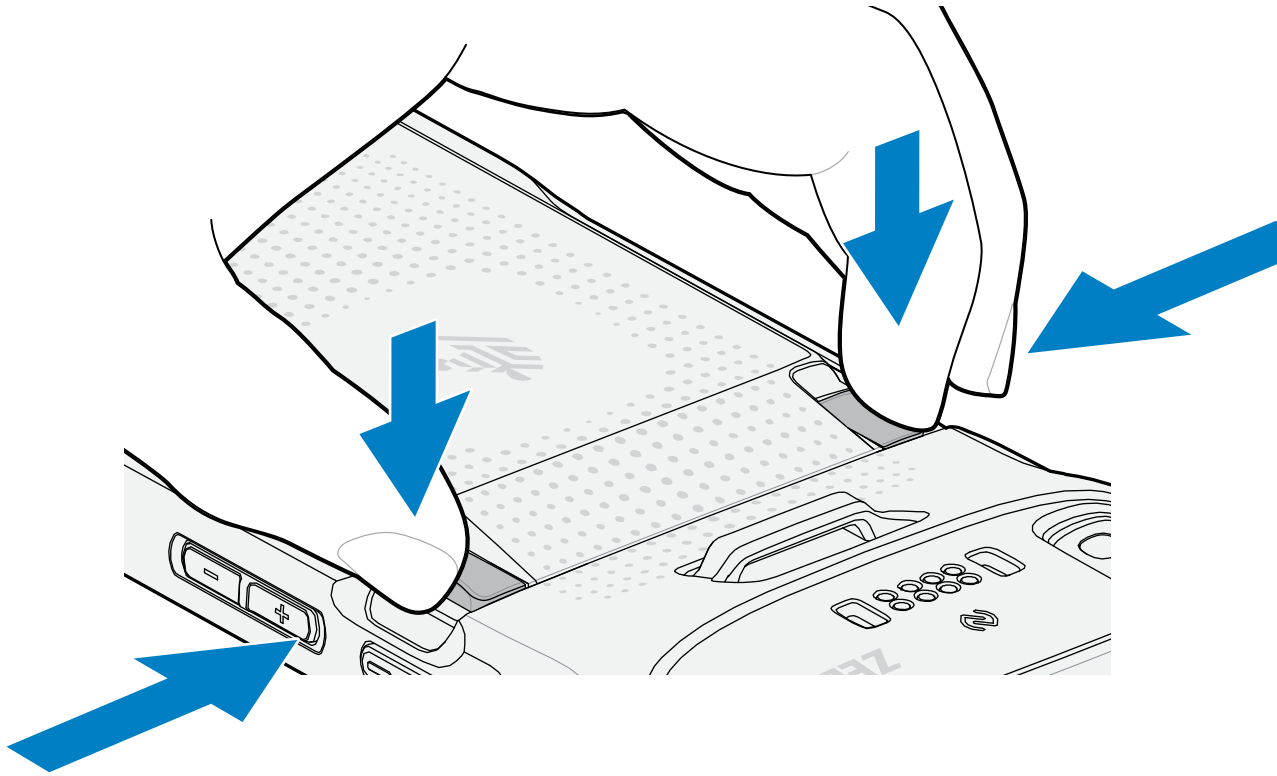

6. Lift the battery from the device.

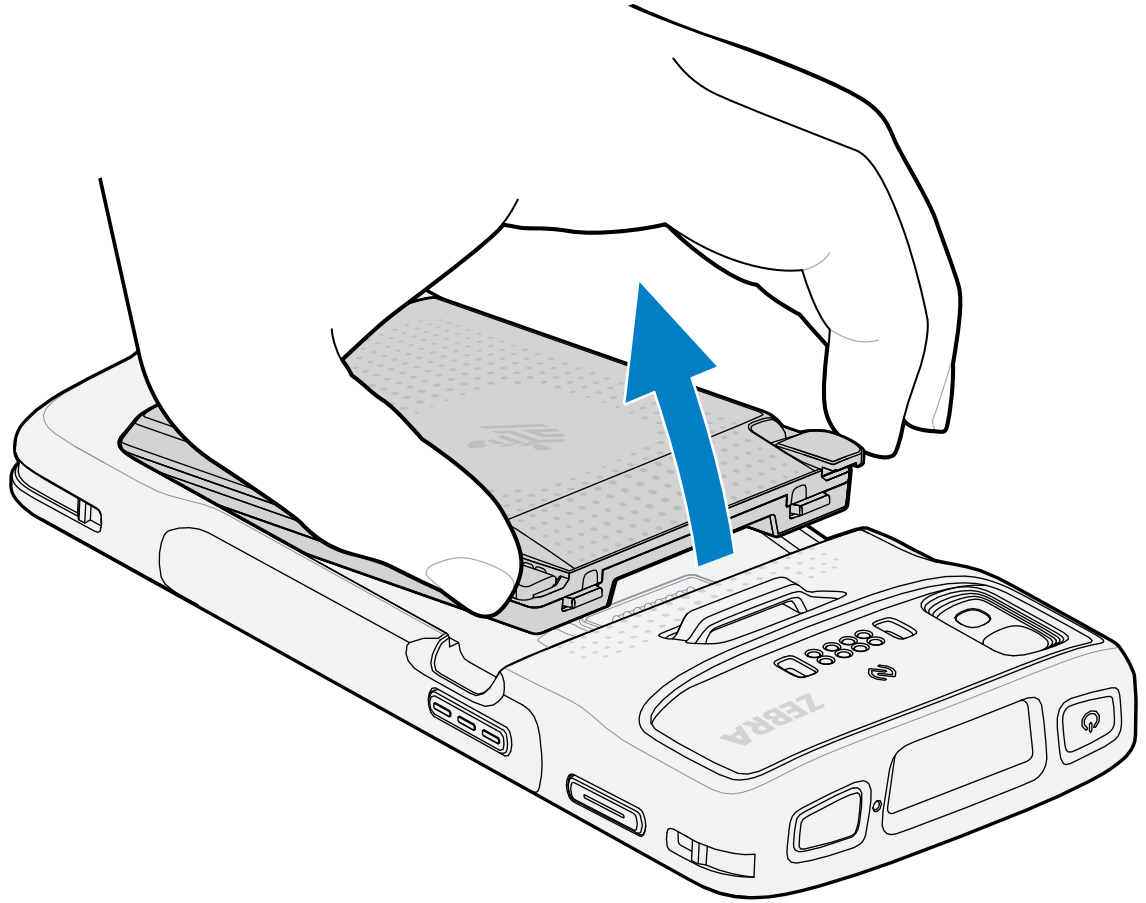

7. Insert the replacement battery, bottom first, into the battery compartment at the back of the device.

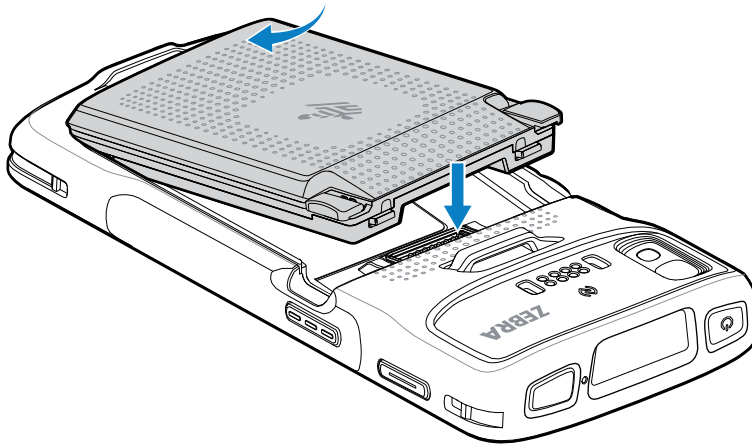

8. Press the battery down until the battery release latches snap into place.
9. Replace the hand strap if required.
10. Press the Power button to turn on the device.

Using the Device

This section explains how to use the device.

Home Screen

Turn on the device to display the Home screen. Depending on how your system administrator configured your device, your Home screen may appear differently than the graphics in this section.

After the device goes into Sleep mode, the Home screen displays with the lock icon. Touch the screen and swipe up to unlock. The Home screen provides four additional screens to place widgets and shortcuts. Touch and hold on an icon, and then move it for the option to place the icon on one of the other screens. Swipe the Home screen left or right to view the additional screens.



NOTE: By default, AOSP devices do not have the same icons on the Home screen as GMS devices. Icons are shown below for example only.

Home screen icons can be configured by the user and may look different than shown.

Figure 3 Home Screen

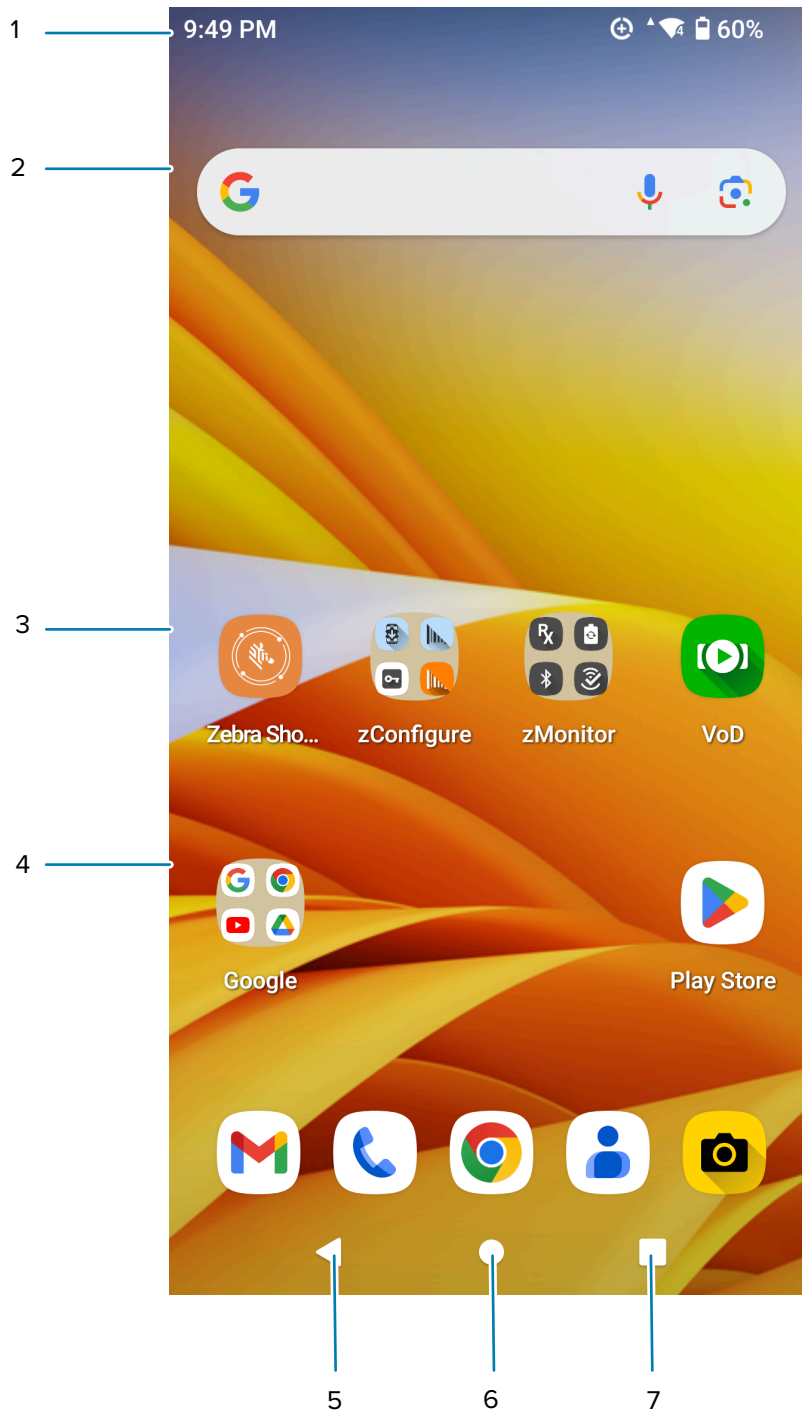

1	Status bar	Displays the time, status icons (right side), and notification icons (left side).
2	Widgets	Launches stand-alone apps that run on the Home screen.
3	Shortcut icons	Opens apps installed on the device

4	Folder	Contains apps.
5	Back	Displays the previous screen.
6	Home	Displays the home screen.
7	Recent	Displays recently used applications.

Setting Home Screen Rotation

By default, the Home screen rotation is disabled.



NOTE: Auto-rotate must be enabled in the Quick Access panel or in Settings before the Home Screen Rotation setting can be used.

1. Touch and hold anywhere on the Home screen until the options appear.
2. Touch **Home settings**.
3. Touch the **Allow Home screen rotation** switch.
4. Touch **Home**.
5. Rotate the device.

Status Bar

The Status bar displays the time, notification icons (left side), and status icons (right side).

If there are more notifications than can fit in the Status bar, a dot displays, indicating that more notifications exist. Swipe down from the Status bar to open the Notification panel and view all notifications and status.

Figure 4 Notifications and Status Icons



1	Notification icons
2	Status icons

Status Icons

Status icons display system information for the device.

Table 4 Status icons

Icon	Description
	Alarm is active.

Table 4 Status icons (Continued)



















Icon	Description
	Main battery is fully charged.
	Main battery is partially drained.
	Main battery charge is low.
	Main battery charge is very low.
	Main battery is charging.
	All sounds, except media and alarms, are muted. Vibrate mode is active.
	All sounds except media and alarms are muted.
	All sounds except media and alarms are muted.
	Do Not Disturb mode active.
	Airplane Mode is active. All radios are turned off.
	Bluetooth is on.
	Connected to a Bluetooth device.
	Connected to a Wi-Fi network. Indicates the Wi-Fi version number.
	Not connected to a Wi-Fi network or no Wi-Fi signal.
	Connected to an Ethernet network.
	Speakerphone enabled.
	Portable Wi-Fi hotspot is active (WWAN only).

Table 4 Status icons (Continued)

Icon	Description
	Indicates that a BT headset is connected to the device.
4G LTE	Connected to a 4G LTE/LTE-CA network (WWAN only). ^a
3G	Connected to a WCDMA network (WWAN only). ^a
E	Connected to an EDGE network (WWAN only). ^a
R ↓↑	Roaming from a network (WWAN only).
	No SIM card installed (WWAN only).

Notification Icons

Notification icons indicate app events and messages.

Table 5 Notification Icons



















Icon	Description
	The main battery is low.
•	More notifications are available for viewing.
	Data is syncing.
	Indicates an upcoming event. AOSP devices only.
	Indicates an upcoming event. GMS devices only.
	An Open Wi-Fi network is available. The device is not connected to it.
	Audio is playing.
	A problem with sign-in or sync has occurred.

Table 5 Notification Icons (Continued)

Icon	Description
	The device is uploading data.
	Animated: the device is downloading data. Static: the download is complete.
	The device is connected to or disconnected from a virtual private network (VPN).
	Preparing internal storage by checking it for errors.
	Call is in progress (WWAN only).
	The mailbox contains one or more voice message (WWAN only).
	A call is on hold (WWAN only).
	A call was missed (WWAN only).
	PTT Express Voice client status.
	The RxLogger app is running.
	A Bluetooth scanner is connected to the device.
	A ring scanner is connected to the device in HID mode.

Managing Notifications

Notification icons report the arrival of new messages, calendar events, alarms, and ongoing events. When a notification occurs, an icon appears in the Status bar with a brief description.

Figure 5 Notification Panel

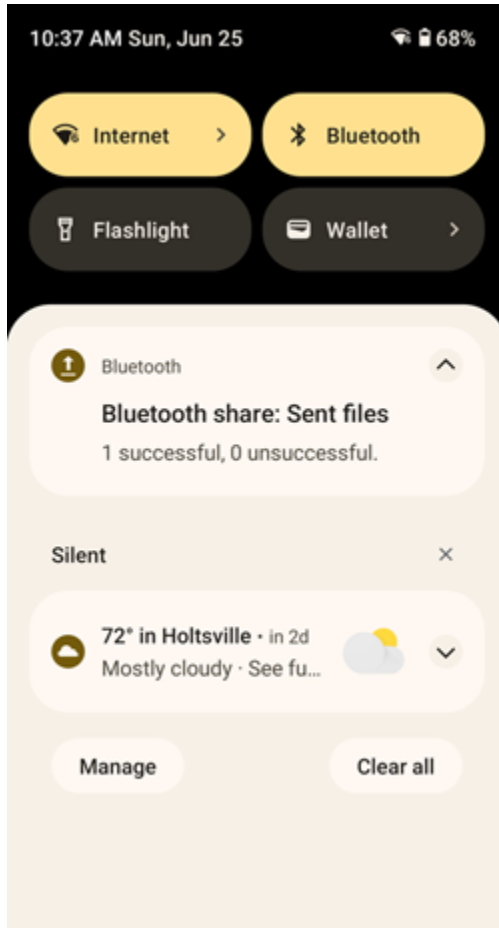

- To view a list of all notifications, open the Notification panel by dragging the Status bar down from the top of the screen.
- To respond to a notification, open the Notification panel and then touch a notification. The Notification panel closes, and the corresponding app opens.
- To manage recent or frequently used notifications, open the Notification panel and then touch Manage notifications. Touch the toggle switch next to an app to turn off all notifications, or touch an app for more notification options.
- To clear all notifications, open the Notification panel and then touch **Clear all**. All event-based notifications are removed. Ongoing notifications remain on the list.
- To close the Notification panel, swipe the Notification panel up.

Opening the Quick Access Panel

Use the Quick Access panel to access frequently used settings (for example, Airplane mode).



NOTE: Not all icons are pictured. Icons may vary.

Figure 6 Quick Access Panel

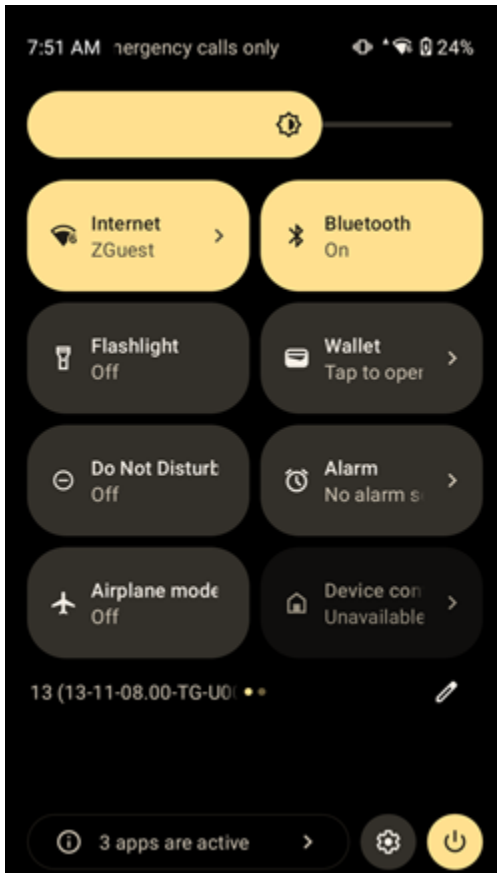

- If the device is locked, swipe down once.
- If the device is unlocked, swipe down once with two fingers or twice with one finger.
- Swipe down from the Quick Settings bar if the Notification panel is open.

Quick Access Panel Icons

Quick Access panel icons indicate frequently used settings (for example, Airplane mode).

Table 6 Quick Access Panel Icons

Icon	Description
	Display brightness - Use the slider to decrease or increase the brightness of the screen.

Table 6 Quick Access Panel Icons (Continued)































Icon	Description
	Internet/Wi-Fi network - Turn Wi-Fi on or off. To open Wi-Fi settings, touch the Wi-Fi network name.
	Battery saver - Turn Battery saver mode on or off. When Battery saver mode is on the performance of the device is reduced to preserve battery power (not applicable).
	Bluetooth settings - Turn Bluetooth on or off. To open Bluetooth settings, touch Bluetooth.
	Invert colors - Invert the display colors.
	Do not disturb - Control how and when to receive notifications.
	Mobile data - Enables or disables data transfer via the WAN. The device is still available for voice calls and texts. To open Mobile data settings, touch and hold (WWAN only).
	Airplane mode - Turn Airplane mode on or off. When Airplane mode is on the device does not connect to Wi-Fi or Bluetooth.
	Auto-rotate - Lock the device's orientation in portrait or landscape mode or set to automatically rotate.
	Flashlight - Turn the flashlight or camera flash on or off. When the flashlight is activated, it stays on unless it is turned off or the camera app is run.
	Location - Enable or disable locationing feature.
	Hotspot - Turn on to share the device's mobile data connection with other devices.
	Data Saver - Turn on to prevent some apps from sending or receiving data in the background.
	Night Light - Tint the screen amber to make it easier to look at the screen in dim light. Set Night Light to turn on automatically from sunset to sunrise, or at other times.
	Screen Cast - Share phone content on Chromecast or a television with Chromecast built-in. On the Cast screen, check the "enable wireless display" option, and then touch "cast screen" to display a list of devices. Touch a device in the list to begin casting.
	Dark Theme - Toggles dark theme on and off. Dark themes reduce the luminance emitted by the screen, while meeting minimum color contrast ratios. It helps improve visual ergonomics by reducing eye strain, adjusting brightness to current lighting conditions, and facilitating screen use in dark environments, while conserving battery power.

Table 6 Quick Access Panel Icons (Continued)

Icon	Description
	Focus mode - Turn on to pause distracting apps. To open Focus mode settings, touch and hold.
	Bedtime mode - Turn grayscale on and off. Grayscale turns the screen black and white, reducing phone distractions and improving battery life.
	Nearby Share - Helps find and interact with services and devices close to the device.
	Screen Record - Makes a video recording of everything that happens on the screen, with options to include audio and screen touches.
	NFC - Enable or disable NFC communication.
	Wallet - Opens Android wallet.
	Alarm - Opens the Alarm app.
	Scan QR code - Opens the camera app for QR code reading.
	Mic access - Enables device microphone.
	Camera access - Enables access to the camera app.
	Extra dim - Reduces screen brightness up to 50%.
	Color correction - Enable to help your device compensate for color blindness.
	Storage - Opens the Files app.
	Live caption - Enables captions to appear for any media playing, regardless of the device's volume level.
	Calculator - Open the calculator app.

Editing Icons on the Quick Settings Bar

The first four setting tiles from the Quick Access panel become the Quick Access tiles on the Notification panel.

Open the Quick Access panel and touch  to edit, add, or remove settings tiles.

Battery Management

Observe the recommended battery optimization tips for the device.

- Set the screen to turn off after a short period of non-use (recommended: 15 seconds).
- Reduce screen brightness (recommended: 30-50%).
- Turn off all wireless radios when not in use.
- Turn off automatic syncing for Email, Calendar, Contacts, and other apps.
- Minimize the use of apps that keep the device from sleeping, for example, music and video apps.



NOTE: Before checking the battery charge level, remove the device from any AC power source (cradle or cable).

Battery status indicates that the battery is discharging and Battery level lists the battery charge (as a percentage of fully charged).

Low Battery Notification

When the battery charge level drops below the change level in the table below, the device displays a notice to connect the device to power. Charge the battery using one of the charging accessories.

Table 7 Low Battery Notification

Charge Level Drops Below	Action
15%	The user should charge the battery soon.
10%	The user must charge the battery.
7%	The device turns off. The user must charge the battery.

Turning Off the Radios

1. Swipe down from the Status bar to open the Quick Settings panel.
2. Touch Airplane mode. The airplane icon  appears in the Status bar indicating that all the radios are off.

Checking Battery Status

Check the battery status through the Battery Information settings, the Battery Manager app, or the quick access panel.

- Open **Settings** and touch **About phone > Battery information**. Or swipe up from the bottom of the screen and touch  to open the **Battery Manager** app.
- Under **Advanced Info**:
 - **Battery present status** indicates if the main battery is present.
 - **Battery level** lists the main battery charge (as a percentage of fully charged).
- Under **Backup Battery Info**:
 - **Wear level** indicates the overall health status of the backup battery.
 - **Backup Battery level** lists the backup battery charge (as a percentage of fully charged). If this value is 1% or less for a long period of time, then the backup battery may need servicing.
- Swipe down with two fingers from the status bar to open the quick access panel. The **battery percentage** displays next to the battery icon.

Monitoring Battery Usage

The Battery screen provides battery charge details and power management options to extend battery life.

Different apps display different information. Some apps include buttons that open screens with settings to adjust power use. To turn off apps that consume too much power, touch the square (recent app) button at the bottom of the home screen. Swipe left or right to view recent applications. Swipe up on an application to close it .

To general battery information:

- Go to **Settings**.
- Touch **Battery**.

To display battery information and power management options for a specific app:

- Go to **Settings**.
- Touch **Apps > See all apps**.
- Select an app.
- Touch **App Battery Usage**. The power management options display. Use **DISABLE** or **FORCE STOP** to turn off apps that consume too much power.

Interactive Sensor Technology

The device contains sensors that monitor movement, orientation, and ambient light.

- Gyroscope - Measures angular rotational velocity to detect rotation of the device.
- Accelerometer - Measures the linear acceleration of movement to detect the orientation of the device.
- Digital Compass - The digital compass or magnetometer provides simple orientation in relation to the Earth's magnetic field. As a result, the device always knows which way is North so it can auto-rotate digital maps, depending on the physical orientation of the device.

- Light Sensor - Detects ambient light and adjusts the screen brightness.
- Proximity Sensor - Detects the presence of nearby objects without physical contact. The sensor detects when the device is close to your face during a call and turns off the screen, preventing unintentional screen touches.
- Pressure Sensor - Measures atmospheric pressure to determine the altitude of the device.

To take advantage of these sensors, applications use API commands. Refer to the Google Android Sensor APIs for more information. For information on the Zebra Android EMDK, go to: techdocs.zebra.com.

Waking the Device

The device goes into Sleep mode when you press **Power** or after a period of inactivity (set in the Display settings window).

1. To wake the device from Sleep mode, press **Power** or the configured wake-up sources.

The Lock screen displays.

2. Swipe the screen up to unlock.

- If the screen option is set to Swipe, the Home screen displays.
- If either the PIN or Password screen unlock feature is enabled, a prompt displays. Enter the PIN or password to unlock the device and move to the Home screen.
- If the Pattern screen unlock feature is enabled, the Pattern screen displays. Swipe the correct pattern between the dots to unlock the device and move to the Home screen.



NOTE: If you enter the PIN, password, or pattern incorrectly five times, you must wait 30 seconds before trying again.

- If you forget the PIN, password, or pattern, contact your system administrator.

USB Communication

Connect the device to a host computer to transfer files between the device and the host computer.

When connecting the device to a host computer, follow the host computer's instructions for connecting and disconnecting USB devices to avoid damaging or corrupting files.

Transferring Files

Use the Transfer files option to copy files between the device and the host computer.



NOTE: It is recommended to install a microSD card in the device for storing files due to limited internal storage.

1. Connect the device to a host computer using a USB accessory.
2. On the device, pull down the Notification panel and touch **Charging this device via USB**.

By default, **No data transfer** is selected.

3. Touch **File Transfer**.



NOTE: After changing the setting to **File Transfer**, and then disconnecting the USB cable, the setting reverts back to **No data transfer**. If the USB cable is reconnected, select **File Transfer** again.

4. Touch **File Transfer**.
5. On the host computer, open **File Explorer**.
6. Locate the **device** as a portable device.
7. Open the **Internal storage** folder.
8. Open the SD card or the Internal storage folder.
9. Copy files to and from the device or delete files as required.

Transferring Photos

Use PTP to copy photos from the device to the host computer.

It is recommended to install a microSD card in the device for storing photos due to limited internal storage.

1. Connect the device to a host computer using a USB accessory.
2. On the device, pull down the Notification panel and touch **Charging this device via USB**.
3. Touch **PTP**.
4. Touch **Transfer photos PTP**.
5. On the host computer, open a file explorer application.
6. Open the **Internal storage** folder.
7. Open the SD card or the Internal storage folder.
8. Copy or delete photos as required.

Disconnecting from the Host Computer



CAUTION: Carefully follow the host computer's instructions to disconnect USB devices correctly to avoid losing information.



NOTE: Carefully follow the host computer's instructions to unmount the microSD card and disconnect USB devices correctly to avoid losing information.



1. On the host computer, unmount the device.
2. Remove the device from the USB accessory.

Settings

This section describes the settings on the device.

Accessing Settings

There are multiple ways to access settings on a device.

- Swipe down with two fingers from the top of the Home screen to open the Quick Access panel and touch .
- Double-swipe down from the top of the Home screen to open the Quick Access panel and touch .
- Swipe up from the bottom of the Home screen to open APPS and touch **Settings**.

Display Settings

Use Display settings to change the screen brightness, enable night light, change the background image, enable screen rotation, set screen timeout, and change font size.

Setting the Screen Brightness Automatically

Automatically adjust the TC22/TC27 screen brightness using the built-in light sensor.

To set the screen brightness automatically:

1. Go to **Settings**.
2. Touch **Display**.
3. If disabled, touch **Adaptive brightness** to adjust the brightness automatically.

By default, **Adaptive brightness** is enabled. Toggle the switch to disable.

Setting the Screen Brightness Manually

Manually set the TC22/TC27 screen brightness using the touchscreen.

To set the screen brightness manually:

1. Swipe down with two fingers from the Status bar to open the Quick Access panel.

- Slide the icon to adjust the screen brightness level.



Setting Night Light

The Night Light setting tints the screen amber, making the screen easier to look at in low light.

- Go to **Settings**.
- Touch **Display > Night Light**.
- Touch **Schedule**.



NOTE: By default, Night Light is disabled. Touch **TURN ON NOW** to enable.

- Select one of the schedule values:
 - None** (default)
 - Turns on the custom time**
 - Turns on from sunset to sunrise.**
- Adjust the tint using the Intensity slider.

Setting Screen Rotation

By default, screen rotation is enabled.



NOTE: To change the Home screen rotation, see [Setting Home Screen Rotation](#) on page 33.

- Go to **Settings**.
- Touch **Display > Auto-rotate screen**.
- Touch Home.

Setting Lock Screen Notifications

The lock screen display setting wakes the screen when notifications are received.

- Go to **Settings**.
- Touch **Display > Lock screen**.
- Touch **Display**.

Setting Display and Text Size

Set the size of the font in system apps.

- Go to **Settings**.
- Touch **Display > Display size and text**.

3. In **Font size**, touch + or - to change the size of the text.
4. In **Display size**, touch + or - to change the size of the display.

Notification LED Brightness Level

1. On Android 11, touch **Display > Advanced**.
2. Touch **Display > Notification LED brightness Level**.
3. Use the slider to set the brightness level (default: 15).

Setting Touch Panel Mode

The device display is able to detect touches using a finger or gloved finger.



NOTE: A glove can be made of medical latex, leather, cotton, or wool. For optimal performance, use a Zebra-certified stylus.

1. Go to **Settings**.
2. Touch **Display > Touch panel mode**.
3. Select:
 - **Glove and Finger**
 - **Finger Only**
4. Touch Home.

Setting the Date and Time

The date and time are automatically synchronized using a NITZ server when the device is connected to a cellular/wireless network. You are only required to set the time zone or set the date and time if the wireless LAN does not support Network Time Protocol (NTP) or when not connected to a cellular/wireless network.

1. Go to **Settings**.
2. Touch **System > Date & time**.
3. Touch **Set time automatically** to disable automatic date and time synchronization.
4. Touch **Set time zone automatically** to disable automatic time-zone synchronization.
5. Touch **Date** to select the date in the calendar.
6. Touch **OK**.
7. Touch **Time**.
 - a) Touch the circle, drag to the current hour, and then release.
 - b) Touch the circle, drag to the current minute, and then release.
 - c) Touch **AM** or **PM**.
8. Touch **OK**.
9. Touch **Time zone** to select the current time zone from the list.
10. Touch **Update Interval** to select an interval to synchronize the system time from the network.

11. In **TIME FORMAT**, choose either **Use locale default** or **Use 24-hour format**.

General Sound Setting

Press the volume buttons on the device to display on-screen volume controls.

Use the Sound settings to configure media and alarm volumes.

1. Go to **Settings**.
2. Touch **Sound**.
3. Touch an option to set sounds.

Sound Options

Use the **Sound & vibration** screen to set various sound and vibration settings.

- **Media volume** - Controls the music, games, and media volume.
- **Call volume** - Controls the volume during a call.
- **Ring & notification volume** - Controls the ringtone and notification volume.
- **Alarm volume** - Controls the alarm clock volume.
- **Do Not Disturb** - Mutes some or all sounds and vibrations.
- **Phone ringtone** - Select a sound to play when the phone rings.
- **Live caption** - Enable the device to detect speech and automatically display captions.
- **Media** - Enable media playback options.
- **Vibration & haptics** - Enables various vibration and haptic feedback.
- **Shortcut to prevent ringing** - Turn on the switch to make the device vibrate when a call is received (default – disabled).
- **Default notification sound** - Select a sound to play for all system notifications.
- **Default alarm sound** - Select a sound to play for alarms.
- **Dial pad tones** - Play a sound when pressing keys on dial pad (default - disabled).
- **Screen locking sounds** - Play a sound when locking and unlocking the screen (default – enabled).
- **Charging sounds and vibration** - Play a sound and vibrate when power is applied to the device (default - enabled).
- **Touch sounds** - Play a sound when making screen selections (default – enabled).
- **Always show icon when in vibrate mode** - Toggle the display of the vibrate icon when in vibrate mode.

Setting Wake-Up Sources

By default, the TC22/TC27 wakes from Sleep mode when the user presses Power. The TC22/TC27 can be configured to wake when the user presses PTT or Scan on the left side of the device.

1. Go to **Settings**.

2. Touch **Wake-Up Sources**.

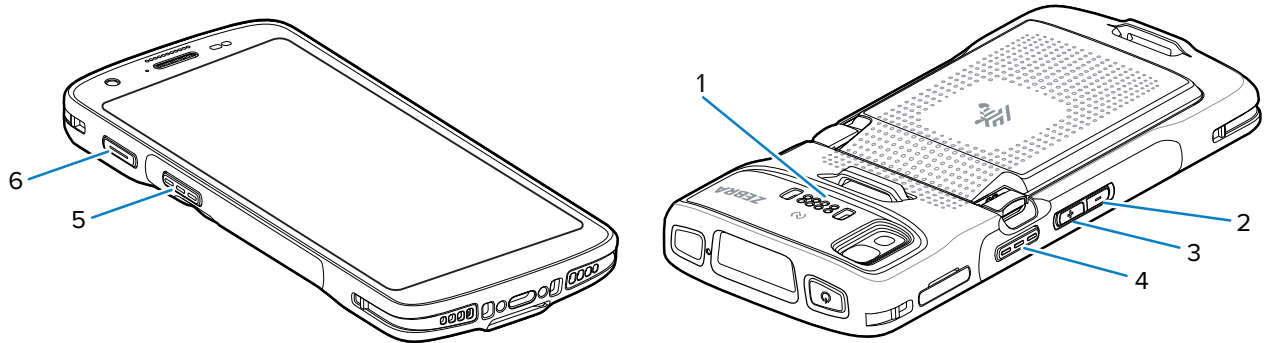

Option	Description
1	Trigger Handle button
2	Volume down button
3	Volume up button
4	Right scan button
5	Left scan button
6	Left programmable button

- **GUN_TRIGGER** - Programmable button on the Trigger Handle accessory.
- **LEFT_TRIGGER_2** - PTT button.
- **REAR_BUTTON** - Programmable button on the back of the device.
- **RIGHT_TRIGGER_1** - Right scan button.
- **SCAN** - Left scan button.

3. Touch a checkbox.

A check appears in the checkbox.

Remapping a Button

Buttons on the device can be programmed to perform different functions or as shortcuts to installed apps. For a list of key names and descriptions, go to techdocs.zebra.com.



NOTE: It is not recommended to remap the scan button.

1. Go to **Settings**.
2. Touch **Key Programmer**. A list of programmable buttons displays.
3. Select the button to remap.
4. Touch the **SHORTCUT**, the **KEYS and BUTTONS**, or the **TRIGGER** tabs that list the available functions, applications, and triggers.

5. Touch a function or application shortcut to map to the button.



NOTE: If you select an application shortcut, the application icon appears next to the button on the Key Programmer screen.

Remapping Keys

List of remappable device keys on the TC22/TC27.

Figure 7 Remappable Keys

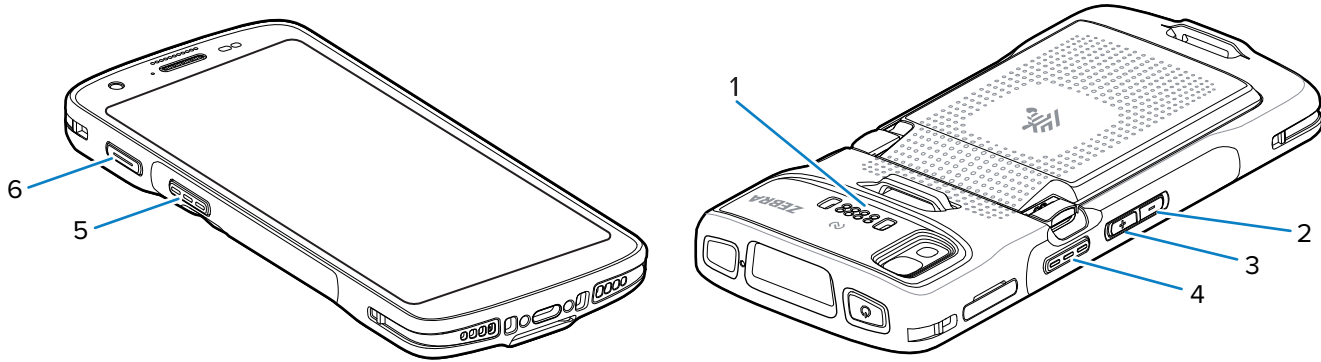

Table 8 Default Key Programmer Settings

Item	Setting	Description
1	BUTTON_L1	Trigger button on attached Trigger Handle.
2	VOLUME_DOWN	Volume down button.
3	VOLUME_UP	Volume up button.
4	BUTTON_R1	Right scan button.
5	SCAN	Left scan button.
6	BUTTON_L2	Left programmable button.
N/A	SYMBOL_TRIGGER_1	Remote Bluetooth scan trigger.

Alert Button

Configure any remappable key on the device as an Alert button using StageNow.

Use an Alert button to launch an app and a command, or call a specified phone number.

Configure the Alert Button

This section provides basic configuration. For detailed information on configuring the Alert button, refer to zebra.techdocs.com/stagenow.

Configure the Alert button through StageNow, using the following Configuration Service Providers (CSPs).

- PowerMgr - Set All Wake-Up Sources to Turn on. This wakes the device if it is in Sleep mode.

- Intent - Create a new setting:
 - Mode - Set to Schedule sending of Intent on key presses.
 - Keep Device Awake - Enable this option to keep the device awake after the short key press.
 - Key Identifier - Select a remappable key. For example, Rear Button.
 - Android Action Name - Enter the action name. For example, to initiate a call, enter `android.intent.action.CALL`.
 - URI - Enter the URI. For example, to call a phone number, enter `tel:123456789`.
- KeyMappingMgr - Modify the default behavior of the button. It is recommended to set this to **None**. Otherwise, the button performs its default behavior and sends out an alert.

Alert Accessibility Service

After the Alert button is configured using StageNow, the Alert Accessibility Service is available on the device.

Go to **Settings > Accessibility > Alert Accessibility service** to enable or disable the alert button. When the device reboots, Alert Accessibility Service is automatically enabled.

Using an Alert Button

Activate the Alert button using a long-press of at least one second to prevent accidental alerts.

- If the device is in Sleep mode, perform a short-press on the Alert button, followed by a long-press.
- If the device is awake, perform a long-press on the Alert button.

Keyboards

The device provides multiple keyboard options.

- Android Keyboard - AOSP devices only
- Gboard - GMS devices only
- Enterprise Keyboard - Only available with Mobility DNA Enterprise License.



NOTE: By default, the Enterprise and Virtual Keyboards are disabled. The Enterprise Keyboard is available for download from the [Zebra Support Site](#).

Enabling Keyboards



1. Go to **Settings**.
2. Touch **System > Languages & input > On-screen keyboard > Manage on-screen keyboards**.
3. Touch a keyboard to enable.

Switching Between Keyboards

To switch between keyboards, touch in a text box to display the current keyboard.



NOTE: By default, the Gboard is enabled. All other virtual keyboards are disabled.

- On the Gboard keyboard, touch and hold  (GMS devices only).
- On the Android keyboard, touch, and hold  (AOSP devices only).
- On the Enterprise keyboard, touch . Only available with Mobility DNA Enterprise License. Not pre-installed on the device. Contact Zebra Support for more information.

Using the Android and Gboard Keyboards

Use the Android or Gboard keyboards to enter text in a text field.

- To configure the keyboard settings, touch and hold "," (comma) and then select **Android keyboard settings**.

Edit Text

Edit entered text and use menu commands to cut, copy, and paste text within or across apps. Some apps do not support editing some or all of the text they display; others may offer their own way to select text.

Entering Numbers, Symbols, and Special Characters

1. Enter numbers and symbols.
 - Touch and hold one of the top-row keys until a menu appears then select a number or special character.
 - Touch the Shift key once for a single capital letter. Touch the Shift key twice to lock in uppercase. Touch the Shift key a third time to unlock Capslock.
 - Touch **?123** to switch to the numbers and symbols keyboard.
 - Touch the **=\<** key on the numbers and symbols keyboard to view additional symbols.
2. Enter special characters.
 - Touch and hold a number or symbol key to open a menu of additional symbols. A larger version of the key displays briefly over the keyboard.

Enterprise Keyboard

The Enterprise Keyboard contains multiple keyboard types.



NOTE: Only available with Mobility DNA Enterprise License.

- Numeric
- Alpha
- Special characters
- Data capture

Numeric Tab

The numeric keyboard is labeled **123**. The keys displayed vary on the app being used. For example, an arrow displays in **Contacts**, however **Done** displays in **Email** account setup.

Alpha Tab

The alpha keyboard is labeled using the language code. For English, the alpha keyboard is labeled **EN**.

Additional Character Tab

The additional characters keyboard is labeled **#*/**.

- Touch  to enter emoji icons in a text message.
- Touch **ABC** to return to the Symbols keyboard.

Scan Tab

The Scan tab provides an easy data capture feature for scanning barcodes.

Language Usage

Use the **Language & input** settings to change the device's language, including words added to the dictionary.

Changing the Language Setting

1. Go to **Settings**.
2. Touch **System > Languages & input**.
3. Touch **Languages**.
A list of available languages displays.
4. If the desired language is not listed, touch **Add a language** and select a language from the list.
5. Touch and hold  to the right of the desired language, then drag it to the top of the list.
The operating system text changes to the selected language.

Adding Words to the Dictionary

1. Go to **Settings**.
2. Touch **System > Languages & input > Personal dictionary**.
If prompted, select the language where this word or phrase is stored.
3. Touch **+** to add a new word or phrase to the dictionary.
4. Enter the word or phrase.
5. In the **Shortcut** text box, enter a shortcut for the word or phrase.

Notifications

Device notification settings allow you to configure how notifications occur on the device, and app notification settings allow you to configure how notifications for a specific app occur.

To view device notification settings, touch **Settings > Apps & notifications > Notifications**.

To view app notifications, touch **Settings > Apps & notifications > App info**, and then select an app.

Enabling Blink Light

The Notification LED lights are blue when an app, such as email and VoIP, generates a programmable notification or to indicate when the device is connected to a Bluetooth device. By default, LED notifications are enabled.

1. Go to **Settings**.
2. Touch **Notifications**.
3. Touch **Blink light** to toggle the notification on or off.

Applications

Apart from the standard pre-installed Android applications, the following table lists Zebra-specific applications installed on the device.

Installed Applications

Aside from the common Google apps, the Zebra-specific apps that are installed on the device are described in this section.

Table 9 Apps











Item	Description
	Battery Manager - Display battery information, including charge level, status, health and wear level.
	Bluetooth Pairing Utility – Use to pair a Zebra Bluetooth scanner with the device by scanning a barcode.
	DataWedge - Enables data capture using the imager.
	DWDemo - Provides a way to demonstrate the data capture features using the imager.
	License Manager - Use to manage software licenses on the device.
	RxLogger - Use to diagnose device and app issues.
	StageNow - Allows the device to stage a device for initial use by initiating the deployment of settings, firmware, and software.

Table 9 Apps (Continued)

Item	Description
	VoD - The Video on Device basic app provides a how-to video for proper device cleaning. For Video on Device licensing information, contact learningservices@zebra.com .
	Wireless Analyzer - A diagnostic intelligent app. Use to diagnose the surrounding area and display network stats, such as coverage hole detection or AP in the vicinity. Refer to the Wireless Analyzer Administrator Guide for Android. Only available with Mobility DNA Enterprise License.
	Zebra Bluetooth Settings - Use to configure Bluetooth logging.
	Zebra Data Services - Use to enable or disable Zebra Data Services. Some options are set by the system administrator.

Accessing Apps

Access all apps installed on the device using the APPS window.

1. On the Home screen, swipe up from the bottom of the screen.
2. Slide the **APPS** window up or down to view more app icons.
3. Touch an icon to open the app.

Switching Between Recent Apps

1. Touch **Recent**.
A window appears on the screen with icons of recently used apps.
2. Slide the apps displayed up and down to view all recently used apps.
3. Swipe left or right to remove the app from the list and force close the app.
4. Touch an icon to open an app or touch **Back** to return to the current screen.

Battery Manager

The Battery Manager provides detailed information about the battery.



Opening Battery Manager

- To open the Battery Manager app, swipe up from the bottom of the Home screen, and then touch .

Battery Manager Information

The Battery Manager displays detailed information about battery charging, health, and status.

Table 10 Battery Icons

Battery Icon	Description
	Battery charge level is between 85% and 100%.
	Battery charge level is between 19% and 84%.
	Battery charge level is between 0% and 18%.

- **Level** - The current battery charge level as a percentage. Displays -% when the level is unknown.
- **Wear** - The health of the battery in graphical form. When the wear level exceeds 80%, the bar color changes to red.
- **Health** - The health of the battery. If a critical error occurs,  appears. Touch to view the error description.
 - **Decommission** - The battery is past its useful life and should be replaced. See system administrator.
 - **Good** - The battery is good.
 - **Charge error** - An error occurred while charging. See system administrator.
 - **Over Current** - An over-current condition occurred. See system administrator.
 - **Dead** - The battery has no charge. Replace the battery.
 - **Over Voltage** - An over-voltage condition occurred. See system administrator.
 - **Below Temperature** - The battery temperature is below the operating temperature. See system administrator.
 - **Failure Detected** - A failure has been detected in the battery. See system administrator.
 - **Unknown** - See system administrator.
- **Charge Status**
 - **Not charging** - The device is not connected to AC power.
 - **Not charging** - The device is not charging.
 - **Charging-AC** - The device is connected to AC power and charging or is fast charging via USB.
 - **Charging-USB** - The device is connected to a host computer with a USB cable and charging.
 - **Discharging** - The battery is discharging.
 - **Full** - The battery is fully charged.
 - **Unknown** - The battery status is unknown.
- **Time until Full** - The amount of time until the battery is fully charged.
- **Time since charging** - The amount of time since the device began charging.

- **Time until empty** - The amount of time until the battery is empty.
- **Advanced info** - Touch to view additional battery information.
 - **Battery present status** - Indicates that the battery is present.
 - **Battery level** - The battery charge level as a percentage of scale.
 - **Battery scale** - The battery scale level used to determine battery level (100).
 - **Battery voltage** - The current battery voltage in millivolts.
 - **Battery temperature** - The current battery temperature in degrees Centigrade.
 - **Battery technology** - The type of battery.
 - **Battery current** - The average current into or out of the battery over the last second in mAh.
 - **Battery manufacture date** - The date of manufacture.
 - **Battery serial number** - The battery serial number. The number matches the serial number printed on the battery label.
 - **Battery part number** - The battery part number.
 - **Battery decommission status** - Indicates if the battery is past its life span.
 - **Battery Good** - The battery is in good health.
 - **Decommissioned Battery** - The battery is past its useful life and should be replaced.
 - **Base cumulative charge** - Cumulative charge using Zebra charging equipment only.
 - **Battery usage number** - The health of the battery as a result of charging and discharging. A high number indicates low battery health.
 - **Usage decommission threshold** - When the Battery usage number is greater than or equal to the Usage decommission threshold, the battery is past its useful life and should be replaced.
 - **Battery error status** - The error status of the battery.
 - **App version** - The application version number.

Camera

This section provides information for taking photos and recording videos using the integrated digital cameras.



NOTE: The device saves photos and videos on the microSD card, if installed and the storage path is changed manually. By default, or if a microSD card is not installed, the device saves photos and videos on internal storage.

On camera only devices without an internal scan engine, the back camera is used for barcode scanning.

When the front camera is used by an app, such as for indoor locationing, the back camera becomes disabled and cannot be used for barcode scanning.

Taking Photos

This section provides information for taking photos using the integrated digital camera.





NOTE: See [Camera Settings](#) on page 61 for camera settings descriptions.

1. Swipe up from the bottom of the Home screen and touch **Camera**.



Option	Description
1	Flash options
2	Quick settings
3	Advanced settings
4	Gallery
5	Shutter button
6	Camera switch

2. If necessary, touch the **PHOTO**
3. To switch between the rear camera and front camera, touch .
4. Frame the subject on the screen.

5. To zoom in or out, press two fingers on the display and pinch or expand your fingers. The zoom controls appear on the screen.
6. Touch an area on the screen to focus. The focus circle appears. The two bars turn green when in focus.
7. Touch .

Recording Videos

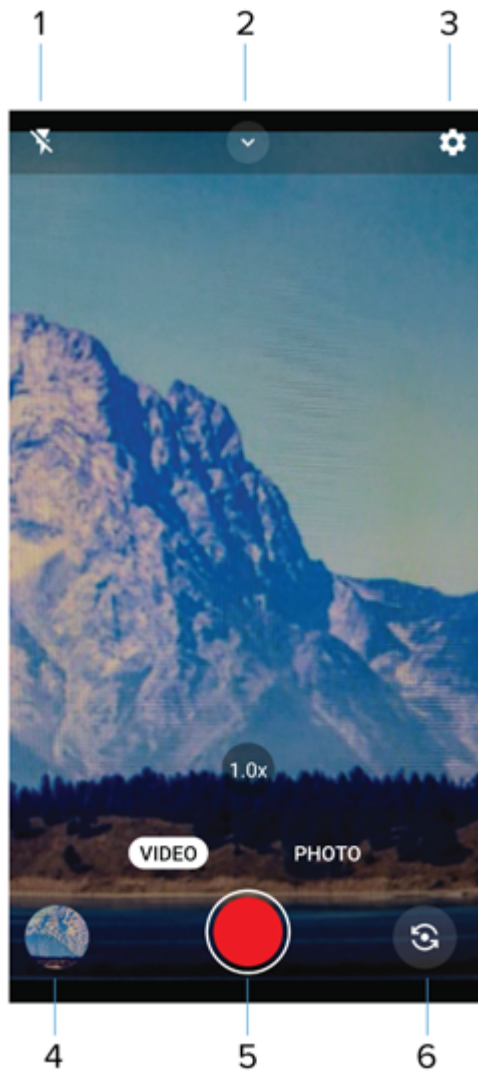

This section provides information for recording videos using the integrated digital camera.

1. Swipe up from the bottom of the Home screen and touch **Camera**.



Option	Description
1	Flash options
2	Quick Settings
3	Advanced settings

Option	Description
4	Gallery
5	Shutter button
6	Camera switch

2. Touch **VIDEO**.
3. To switch between the rear camera and front camera (if available), touch .
4. Point the camera and frame the scene.
5. To zoom in or out, press two fingers on the display and pinch or expand your fingers. The zoom controls appear on the screen.
6. Touch  to start recording.
The video time remaining appears in the top of the screen.
7. Touch  to end the recording.

Camera Settings

Settings vary depending on whether the front or rear camera is active.

- **General**
 - **Camera Sounds** - Select to play a shutter sound when taking a photo. Options: Disable or Enable (default).
 - **Location Tags** - Includes location information when pictures and videos are taken.
 - **Storage** - Set the location to store the photo to: Phone or SD Card.
 - **Dirty Lens Detection** - Notifies when the camera lens might be dirty. Options: Disable (default) or Enable.
 - **QR Code Mode** - Enable to scan QR Codes with the option to launch URL. Options: Disable (default) or Enable.
 - **Digital Level** - Display a level line to ensure the photo or video is level. Options: Disable (default) or Enable.
 - **Face Detection** - Select to turn face detection Off (default) or On.
 - **Gestures** - View gestures and power user controls. Gestures include: Swipe Down, Swipe Up, Side Swipe, Tap, Tap + Hold, Double Tap, and Hold Zoom.

- **Still camera**
 - **Photo Grid** - Displays a 3 x 3 grid guide on the camera viewport. Options: Disabled (default), or Enable.
 - **Countdown timer** - Select Off (default), 2 seconds, 5 seconds or 10 seconds.
 - **Picture size** - The size (in pixels) of the photo to: 16M pixels (rear camera only, default), 8M pixels, 5M pixels (front camera default), WVGA, VGA, or QVGA.
 - **Picture quality** - Set the picture quality setting to: Low, Standard, or High (default).
 - **Picture Format** - Save still images as JPEG (default), or RAW+JPEG.
 - **MFNR** - Sets multi-frame noise reduction to improve quality in low light conditions. Options: Enabled (default), or Disabled.
 - **AF Animation** - Select to enable or disable the camera focus ring in the camera preview. Options: Disable (default) or Enable.
- **Video camera**
 - **Video quality** - Set video quality to: 4k UHD, HD 1080p (default), HD 720p, SD 480p, VGA, CIF, or QVGA.
 - **Video duration** - Set to: 30 seconds (MMS), 10 minutes (default), 30 minutes, or no limit.
 - **Image Stabilization** - Set to reduce blurry videos due to device movement. Options: On or Off (default).
 - **Noise Reduction** - Off (default), Fast, or High Quality.
 - **HEVC Encoder** - Save video recordings using high-efficiency video codec (HEVC/h265) for smaller file size. Options: Disabled (default), or Enable.
 - **Audio Encoder** - Set the audio encoder to: AMRNB, or AAC (default).
 - **Video Rotation** - Set the rotation of the video to: 0 (default), 90, 180, or 270.
- **System**
 - **Restore defaults** - Select to restore all settings to the default values.
 - **About** - Displays the software version of the camera app.

DataWedge

DataWedge is a utility that adds advanced barcode scanning capability to any application without writing code. It runs in the background and handles the interface to built-in barcode scanners. The captured barcode data is converted to keystrokes and sent to the target application as if it was typed on the keypad.

DataWedge allows any app on the device to get data from input sources such as a barcode scanner, MSR, RFID, voice, or serial port and manipulate the data based on options or rules.

Configure DataWedge to:









- Provide data capture services from any app.
- Use a particular scanner, reader, or other peripheral devices.
- Properly format and transmit data to a specific app.

To configure DataWedge, refer to techdocs.zebra.com/datawedge/.

DWDemo Icons

This table lists the icons available on the DWDemo app.

Table 11 DWDemo Icons

Category	Icon	Description
Illumination		Imager illumination is on. Touch to turn illumination off.
Illumination		Imager illumination is off. Touch to turn illumination on.
Data Capture		The data capture function is through the internal imager.
Data Capture		The data capture function is through the rear camera.
Data Capture		A Bluetooth scanner is connected.
Data Capture		A Bluetooth scanner is not connected.
Scan Mode		Imager is in picklist mode. Touch to change to normal scan mode.
Scan Mode		Imager is in normal scan mode. Touch to change to picklist mode.
Menu		Opens a menu to view the application information or to set the application DataWedge profile.

Selecting a Scanner

See the Data Capture section for more information.

1. To select a scanner, touch  > **Settings** > **Scanner Selection**.
2. Press the programmable button or touch the yellow scan button to capture data.
The data appears in the text field below the yellow button.
3. Press the scanner trigger button or touch the on-screen yellow scan button to capture data.
The data appears in the text field below the yellow button.

RxLogger

RxLogger is a comprehensive diagnostic tool that provides application and system metrics, and diagnoses device and application issues.

RxLogger logs the following information: CPU load, memory load, memory snapshots, battery consumption, power states, wireless logging, cellular logging, TCP dumps, Bluetooth logging, GPS logging, logcat, FTP push/pull, ANR dumps, etc. All generated logs and files are saved onto flash storage on the device (internal or external).

RxLogger logs the following information: CPU load, memory load, memory snapshots, battery consumption, power states, wireless logging, TCP dumps, Bluetooth logging, logcat, FTP push/pull, ANR dumps, etc. All generated logs and files are saved onto flash storage on the device (internal or external).

RxLogger Configuration

RxLogger is built with an extensible plug-in architecture and comes packaged with a number of plug-ins already built-in. For information on configuring RxLogger, refer to techdocs.zebra.com/rxlogger/.

To open the configuration screen, from the RxLogger home screen, touch **Settings**.

Configuration File

All RxLogger settings are stored in a file on the device, permitting remote configuration and mass deployment of setting files using an enterprise mobile management (EMM) system.

The config.json configuration file is located on the microSD card in the RxLogger\config folder. Copy the file from the device to a host computer using a USB connection. Edit the configuration file and then replace the JSON file on the device. There is no need to stop and restart the RxLogger service because the file change is automatically detected.



IMPORTANT: The RxLogger configuration file is human-readable; however, it should not be edited by hand as doing so can lead to unpredictable behavior. Zebra recommends modifying RxLogger settings only through the RxLogger UI.

- File name: `config.json`
- Location: `<internal_storage>/RxLogger`
- With external SD Card: `/storage/sdcard1/RxLogger`
- With no external SD Card: `/storage/sdcard0/RxLogger` When a new settings file is pushed to the device, RxLogger restarts all affected modules and applies the new settings immediately.

Copy the file from the device to a host computer using a USB connection. Edit the configuration file through the RxLogger UI and then replace the JSON file on the device. There is no need to stop and restart the RxLogger service because the file change is automatically detected.

Enabling Logging

1. Swipe the screen up and select .
2. Touch **Start**.

Disabling Logging

1. Swipe the screen up and select .
2. Touch **Stop**.

Extracting Log Files

1. Connect the device to a host computer using a USB connection.
2. Using a file explorer, navigate to the RxLogger folder.
3. Copy the file from the device to the host computer.
4. Disconnect the device from the host computer.

Backing Up Data

RxLogger Utility allows the user to make a zip file of the RxLogger folder in the device, which by default contains all the RxLogger logs stored in the device.

- To save the backup data, touch  > **BackupNow**.

RxLogger Utility

RxLogger Utility is a data monitoring application for viewing logs in the device while RxLogger is running. Logs and RxLogger Utility features are accessed using Main Chat Head.

Initiating the Main Chat Head

1. Open **RxLogger**.
2. Touch  > **Toggle Chat Head**.
The Main Chat Head icon appears on the screen.
3. Touch and drag the Main Chat Head icon to move it around the screen.

Removing the Main Chat Head

1. Touch and drag the icon.
A circle with an X appears.
2. Move the icon over the circle and then release.

Viewing Logs

1. Touch the Main Chat Head icon.
The RxLogger Utility screen displays.
2. Touch a log to open it.
Open many logs with each displaying a new Sub Chat Head.
3. If necessary, scroll left or right to view additional Sub Chat Head icons.

4. Touch a Sub Chat Head to display the log contents.

Removing a Sub Chat Head Icon

- To remove a Sub Chat Head icon, press and hold the icon until it disappears.

Backing Up In Overlay View

RxLogger Utility allows the user to make a zip file of the RxLogger folder in the device, which by default contains all the RxLogger logs stored in the device.

The Backup icon is always available in Overlay View.

1. Touch .

The Backup dialog box appears.

2. Touch **Yes** to create the backup.

Data Capture

This section provides information for capturing barcode data using various scanning options.

The device supports data capture using:

- Integrated Imager
- Integrated Camera
- RS507/RS507x Hands-Free Imager
- RS5100 Bluetooth Ring Scanner
- RS6000 Bluetooth Ring Scanner
- RS6100 Bluetooth Ring Scanner
- LI3678 Linear Scanner
- LI3608 Linear Scanner
- DS8108 Digital Scanner
- DS8178 Digital Scanner
- DS3678 Digital Scanner
- DS3608 Digital Scanner
- DS2278 Digital Scanner

Imaging

The device with an integrated 2D imager has the following features:

- Omnidirectional reading of a variety of barcode symbologies, including the most popular linear, postal, PDF417, Digimarc, and 2D matrix code types.
- The ability to capture and download images to a host for a variety of imaging applications.
- Advanced intuitive laser aiming cross-hair and dot aiming for easy point-and-shoot operation.

The imager uses imaging technology to take a picture of a barcode, stores the resulting image in memory, and executes state-of-the-art software decoding algorithms to extract the barcode data from the image.

Digital Camera

The device with an integrated camera based barcode scanning solution has the following features:



NOTE: The integrated camera is intended for light-duty barcode scanning. For heavy-duty scanning, 100 or more scans per day, use the 2D imager.

- Omnidirectional reading of a variety of barcode symbologies, including the most popular linear, postal, QR, PDF417, and 2D matrix code types.
- Cross-hair reticle for easy point-and-shoot operation.
- Picklist mode to decode a particular barcode from many in the field of view.

The solution uses the advanced camera technology to take a digital picture of a barcode, and executes state-of-the-art software decoding algorithms to extract the data from the image.

On camera only devices without an internal scan engine, the back camera is used for barcode scanning.

Operational Modes

The device with an integrated imager supports three modes of operation.

Activate each mode by pressing **Scan**.

- Decode mode — The device attempts to locate and decode enabled barcodes within its field of view. The imager remains in this mode as long as you hold the scan button, or until it decodes a barcode.



NOTE: To enable Picklist Mode, configure in DataWedge or set in an application using an API command.

- Picklist mode — Selectively decode a barcode when more than one barcode is in the device's field of view by moving the aiming crosshair or dot over the required barcode. Use this feature for pick lists containing multiple barcodes and manufacturing or transport labels containing more than one barcode type (either 1D or 2D).



NOTE: To enable MultiBarcode Mode, configure in DataWedge or set in an application using an API command.

- MultiBarcode Mode — In this mode, the device attempts to locate and decode a specific number of unique barcodes within its field of view. The device remains in this mode as long as you hold the scan button, or until it decodes all the barcodes.
 - The device attempts to scan the programmed number of unique barcodes (from 2 through 100). This may be a fixed amount, meaning it scans X unique barcodes, or can be set as a range to scan a different number of unique barcodes each session.
 - If there are duplicate barcodes (same symbology type and data), only one of the duplicate barcodes is decoded and the remainder are ignored. If the label has two duplicate barcodes plus another two different barcodes, a maximum of three barcodes will be decoded from that label; one will be ignored as a duplicate.
 - Barcodes can be of multiple symbology types and still be acquired together. For example, if the specified quantity for a MultiBarcode Mode scan is four, two barcodes can be symbology type Code 128 and the other two can be symbology type Code 39.
 - If the specified number of unique barcodes is not initially in view of the device, the device will not decode any data until the device is moved to capture the additional barcode(s) or time out occurs. If the device field of view contains a number of barcodes greater than the specified quantity, the

device randomly decodes barcode(s) until the specified number of unique barcodes is reached. For example, if the count is set to two and eight barcodes are in the field of view, the device decodes the first two unique barcodes it sees, returning the data in random order.

- MultiBarcode Mode does not support concatenated barcodes.

Scanning Considerations

Typically, scanning is a simple matter of aim, scan, and decode, with a few quick trial efforts to master it.

However, consider the following to optimize scanning performance:

- Range — Scanners decode optimally over a particular working range — minimum and maximum distances from the barcode. This range varies according to barcode density and scanning device optics. Scan within range for quick and constant decodes; scanning too close or too far away prevents decodes. Move the scanner closer and further away to find the right working range for the barcodes being scanned.
- Angle — Scanning angle is important for quick decodes. When the illumination/flash reflects directly back into the imager, the specular reflection can blind/saturate the imager. To avoid this, scan the barcode so that the beam does not bounce directly back. Do not scan at too sharp an angle; the scanner needs to collect scattered reflections from the scan to make a successful decode. Practice quickly shows what tolerances to work within.
- Hold the device farther away for larger symbols.
- Move the device closer for symbols with bars that are close together.



NOTE: Scanning procedures depend on the app and device configuration. An app may use different scanning procedures from the one listed above.

Scanning with Internal Imager

To read a barcode, a scan-enabled application is required. The device contains the DataWedge application, which allows you to enable the imager, decode the barcode data, and display the barcode content.



NOTE: The SE55 displays a green dash-dot-dash aimer. The SE4710 imager displays a red dot aimer.

1. Ensure that an application is open on the device, and a text field is in focus (text cursor in text field).

2. Point the scanner exit window of the device at a barcode.

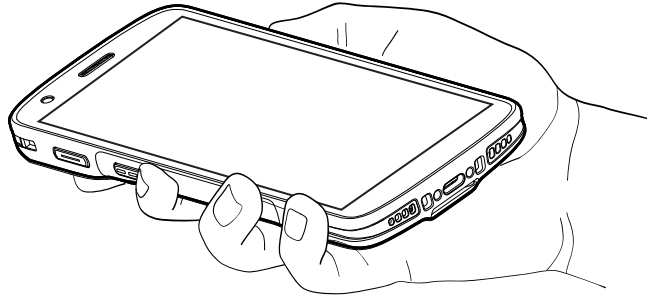
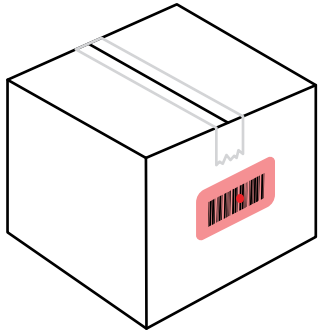

3. Press and hold the scan button.

The device projects the aiming pattern.



NOTE: When the device is in Pick List Mode, the device does not decode the barcode until the center of the dot touches the barcode.

4. Ensure the barcode is within the area formed by the aiming pattern. The aiming dot is used for increased visibility in bright lighting conditions.

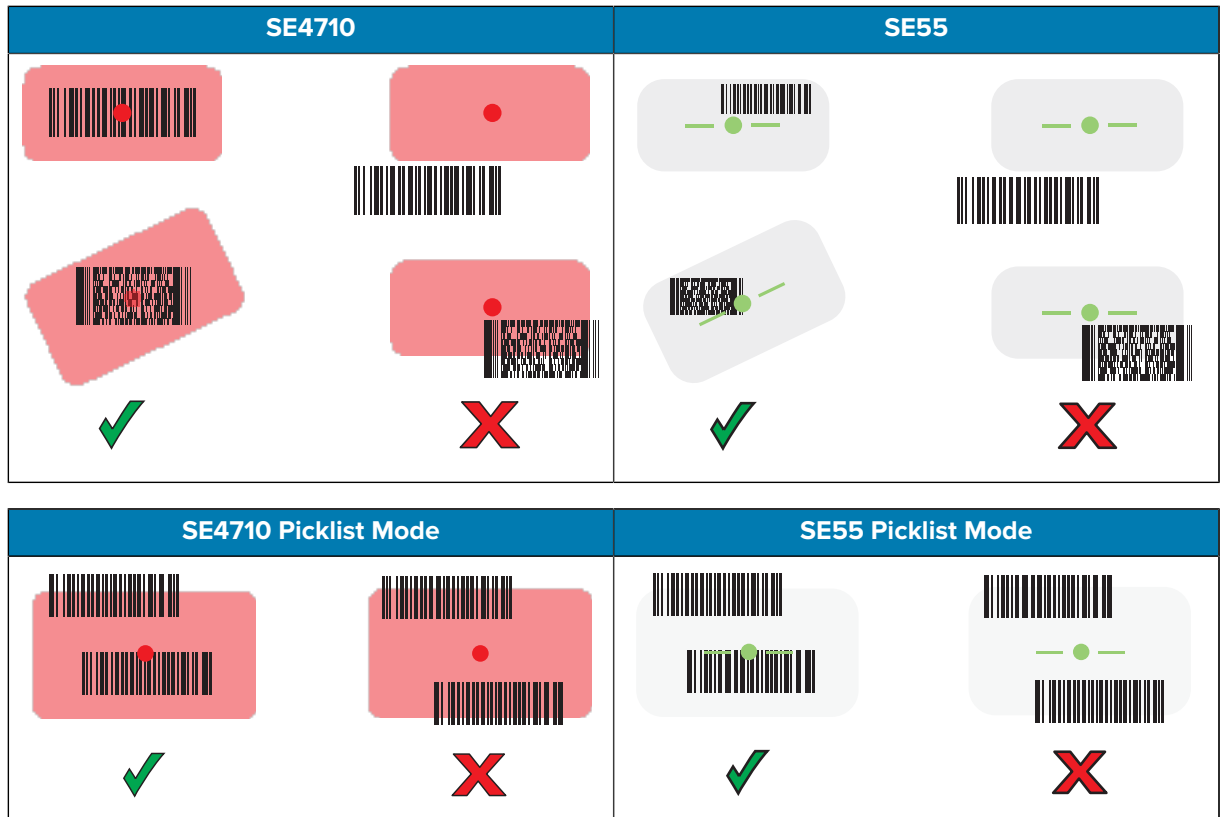

The Data Capture LED light turns on, and the device beeps, by default, to indicate that the barcode was decoded successfully.

5. Release the scan button.



NOTE: Imager decoding usually occurs instantaneously. The device repeats the steps required to take a digital picture (image) of a poor or difficult barcode as long as the scan button remains pressed.

The device displays the barcode data in the text field.

Scanning with the Camera

Use the internal camera to capture barcode data.



NOTE: To read a barcode, a scan-enabled app is required. The device contains the DataWedge app that allows the user to enable the scanner to decode barcode data and display the barcode content.



NOTE: The integrated camera is intended for light-duty barcode scanning. For heavy-duty scanning, 100 or more scans per day, use the 2D imager.

When capturing barcode data in poor lighting, turn on Illumination mode in the DataWedge application.

To scan with the internal camera:

1. Point the camera window at a barcode.



NOTE: When Picklist mode is enabled, move the device until the barcode is centered under the red target on the screen.

2. Launch a scanning application.
3. Press and hold the scan button. By default, a preview window appears on the screen.
4. Move the device until the barcode is visible on the screen.
5. The Decode LED lights green, a beep sounds and the device vibrates, by default, to indicate the barcode is decoded successfully.
6. The captured data appears in the text field.
7. Release the scan button.

Scanning with the RS507/RS507X Hands-Free Imager

Use the RS507/RS507X Hands-Free Imager to capture barcode data.

Figure 8 RS507/RS507X Hands-Free Imager



Refer to the RS507/RS507X Hands-free Imager Product Reference Guide for more information.



NOTE: To read a barcode, a scan-enabled app is required. The device contains the DataWedge app that allows the user to enable the scanner to decode barcode data and display the barcode content.

To scan with the RS507/RS507x:

1. Pair the RS507/RS507X with the device.
2. Ensure that an app is open on the device and a text field is in focus (text cursor in text field).

3. Point the RS507/RS507X at a barcode.

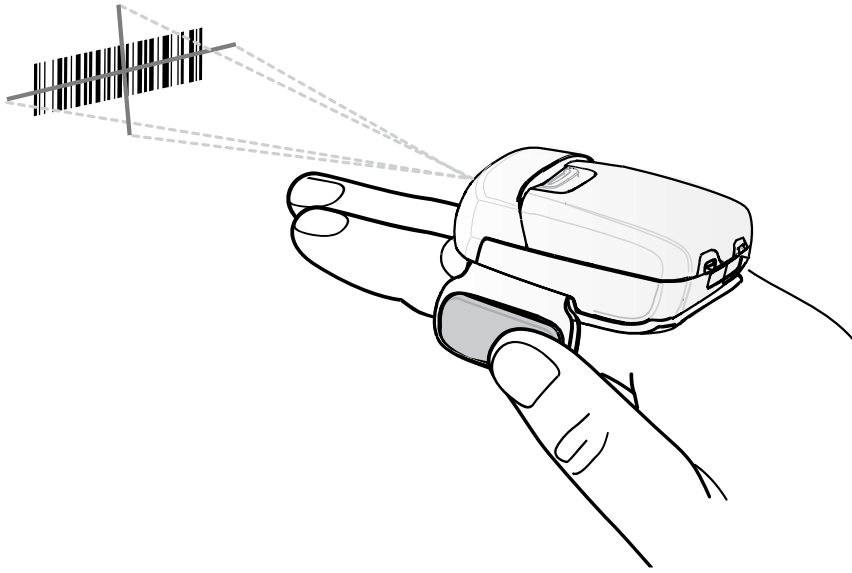

4. Press and hold the trigger.

The red laser aiming pattern turns on to assist in aiming. Ensure the barcode is within the area formed by the cross-hairs in the aiming pattern. The aiming dot increases visibility in bright lighting conditions.

Figure 9 RS507/RS507X Aiming Pattern

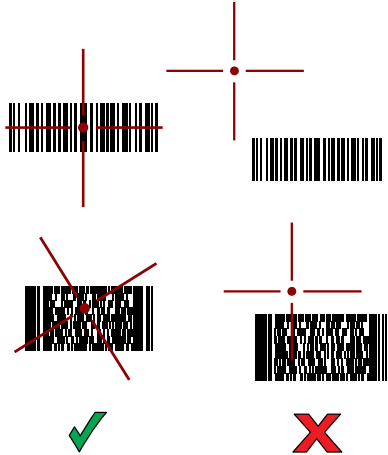

When the RS507/RS507X is in Pick List mode, the RS507/RS507X does not decode the barcode until the center of the crosshair touches the barcode.

Figure 10 RS507/RS507X Pick List Mode with Multiple Barcodes in Aiming Pattern

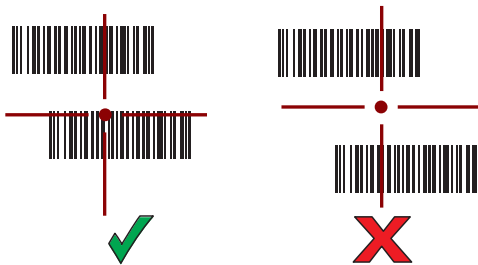

The RS507/RS507X LEDs light green and a beep sounds to indicate the barcode was decoded successfully.

The captured data appears in the text field.

Scanning with the RS5100 Ring Scanner

Use the RS5100 Ring Scanner to capture barcode data.

Figure 11 RS5100 Ring Scanner

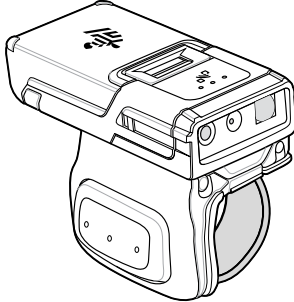

Refer to the RS5100 Ring Scanner Product Reference Guide for more information.



NOTE: To read a barcode, a scan-enabled app is required. The device contains the DataWedge app that allows the user to enable the scanner to decode barcode data and display the barcode content.

To scan with the RS5100:

1. Pair the RS5100 with the device.
2. Ensure that an app is open on the device and a text field is in focus (text cursor in text field).
3. Point the RS5100 at a barcode.

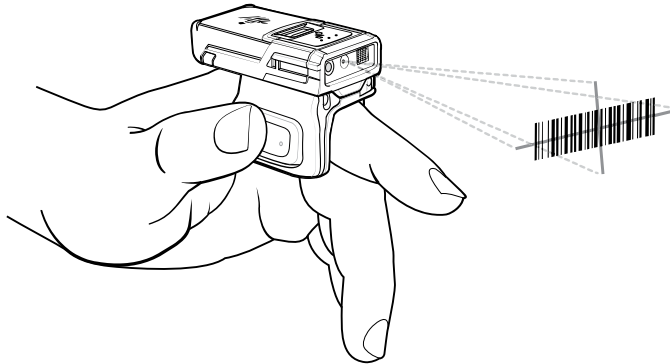

4. Press and hold the trigger.

The red laser aiming pattern turns on to assist in aiming. Ensure the barcode is within the area formed by the cross-hairs in the aiming pattern. The aiming dot increases visibility in bright lighting conditions.

Figure 12 RS5100 Aiming Pattern

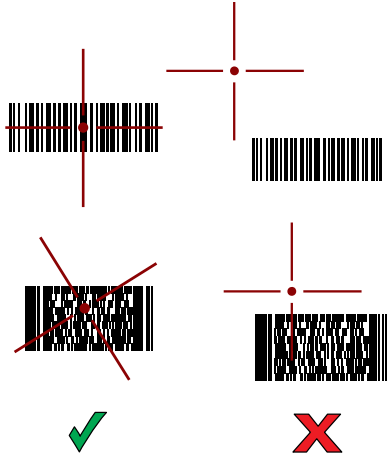

When the RS5100 is in Pick List mode, the RS5100 does not decode the barcode until the center of the crosshair touches the barcode.

Figure 13 RS5100 Pick List Mode with Multiple Barcodes in Aiming Pattern



The RS5100 LEDs light green and a beep sounds to indicate the barcode was decoded successfully. The captured data appears in the text field.

Scanning with the RS6000 Bluetooth Ring Scanner

Use the RS6000 Bluetooth Ring Scanner to capture barcode data.

Figure 14 RS6000 Bluetooth Ring Scanner

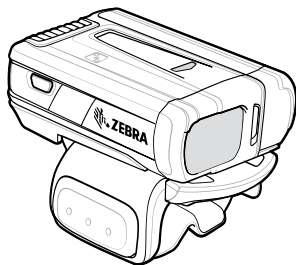

Refer to the RS6000 Bluetooth Ring Scanner Product Reference Guide for more information.



NOTE: To read a barcode, a scan-enabled app is required. The device contains the DataWedge app that enables the user to use the scanner to decode barcode data and display the barcode content.

To scan with the RS6000:

1. Pair the RS6000 with the device.
2. Ensure that an app is open on the device and a text field is in focus (text cursor in text field).
3. Point the RS6000 at a barcode.

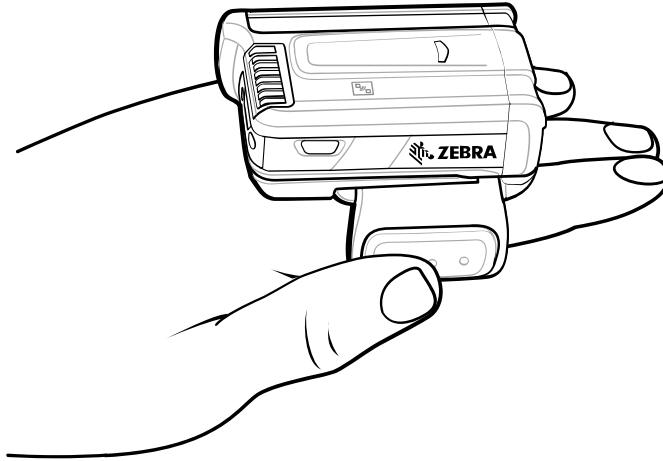

4. Press and hold the trigger.

The red laser aiming pattern turns on to assist in aiming. Ensure the barcode is within the area formed by the cross-hairs in the aiming pattern. The aiming dot increases visibility in bright lighting conditions.

Figure 15 RS6000 Aiming Pattern

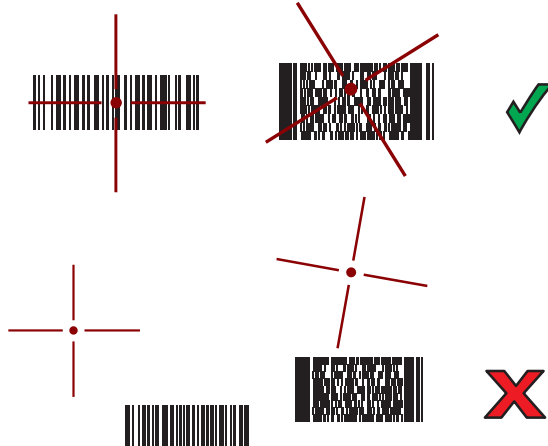

When the RS6000 is in Pick List mode, the RS6000 does not decode the barcode until the center of the crosshair touches the barcode.

Figure 16 RS6000 Pick List Mode with Multiple Barcodes in Aiming Pattern



The RS6000 LEDs light green and a beep sounds to indicate the barcode was decoded successfully. The captured data appears in the text field.

Scanning with the RS6100 Bluetooth Ring Scanner

Use the RS6100 Bluetooth Ring Scanner to capture barcode data.

Figure 17 RS6100 Bluetooth Ring Scanner

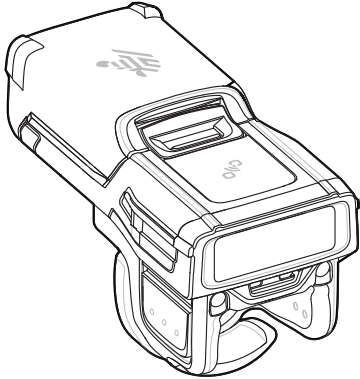

Refer to the RS6100 Bluetooth Ring Scanner Product Reference Guide for more information.



NOTE: To read a barcode, a scan-enabled app is required. The device contains the DataWedge app that allows the user to enable the scanner to decode barcode data and display the barcode content.

To scan with the RS6100:

1. Pair the RS6100 with the device.
2. Ensure that an app is open on the device and that a text field is in focus (text cursor in text field).
3. Point the RS6100 at a barcode.

4. Press and hold the trigger.

The green laser aiming pattern turns on to assist in aiming. Ensure the barcode is within the area formed by the cross-hairs in the aiming pattern. The aiming dot increases visibility in bright lighting conditions.

Figure 18 RS6100 Aiming Pattern



When the RS6100 is in Pick List mode, the RS6100 does not decode the barcode until the center of the crosshair touches the barcode.

Figure 19 RS6000 Pick List Mode with Multiple Barcodes in Aiming Pattern



The RS6100 LEDs light green and a beep sounds to indicate the barcode was decoded successfully. The captured data appears in the text field.

Scanning with the LI3678 Linear Imager

Use the LI3678 linear imager to capture barcode data.

Figure 20 LI3678 Bluetooth Scanner

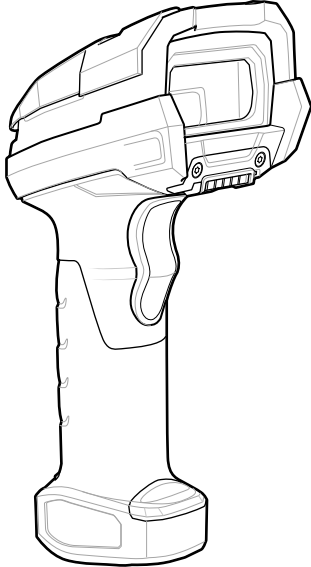

Refer to the LI3678 Product Reference Guide for more information.



NOTE: To read a barcode, a scan-enabled app is required. The device contains the DataWedge app that allows the user to enable the scanner to decode barcode data and display the barcode content.

To scan with the LI3678:

1. Pair the LI3678 with the device. See [Pairing a Bluetooth Scanner](#) for more information.
2. Ensure that an app is open on the device and a text field is in focus (text cursor in text field).
3. Point the LI3678 at a barcode.
4. Press and hold the trigger.

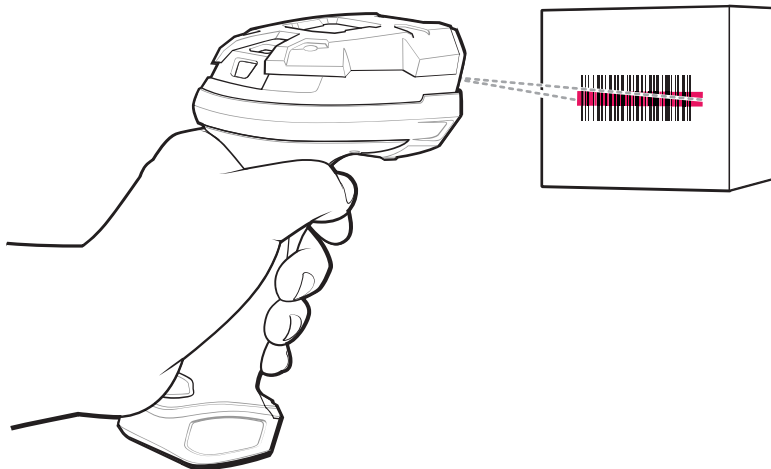

5. Ensure the aiming pattern covers the barcode.

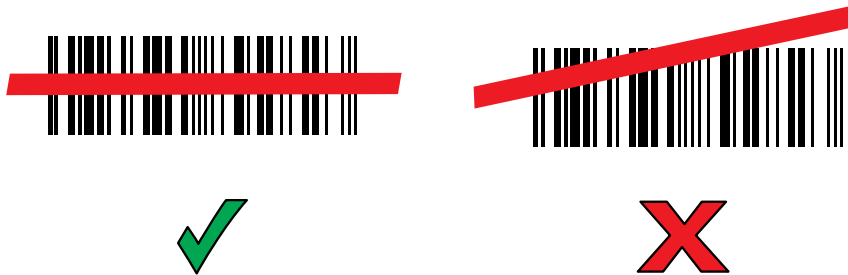

Upon successful decode, the scanner beeps and the LED displays a single green flash.
The captured data appears in the text field.

Scanning with the LI3608 Linear Scanner

Use the LI3608 linear imager to capture barcode data.

Figure 21 LI3608 Bluetooth Scanner

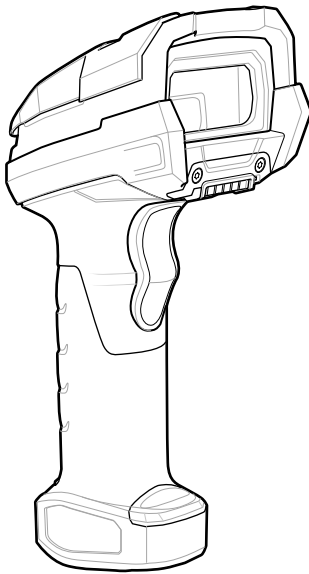

Refer to the LI3608 Product Reference Guide for more information.



NOTE: To read a barcode, a scan-enabled app is required. The device contains the DataWedge app that allows the user to enable the scanner to decode barcode data and display the barcode content.

To scan with the LI3608:

1. Connect the LI3608 to the device.
2. Ensure that an app is open on the device and a text field is in focus (text cursor in text field).
3. Point the LI3608 at a barcode.

4. Press and hold the trigger.

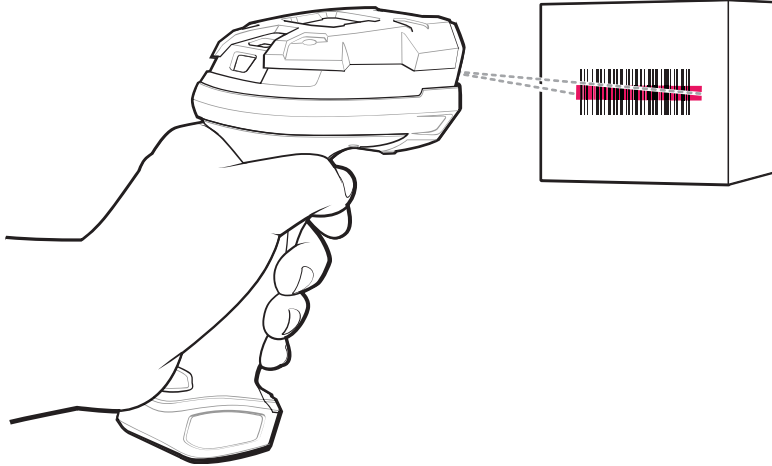

5. Ensure the aiming pattern covers the barcode.

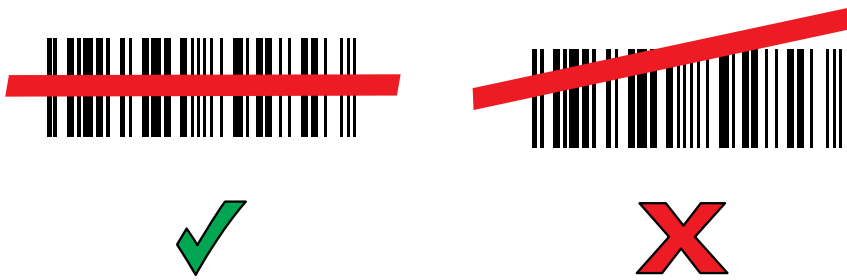

Upon successful decode, the scanner beeps and the LED displays a single green flash.
The captured data appears in the text field.

Scanning with the DS8178 Digital Scanner

Use the DS8178 Bluetooth Scanner to capture barcode data.

Figure 22 DS8178 Digital Scanner

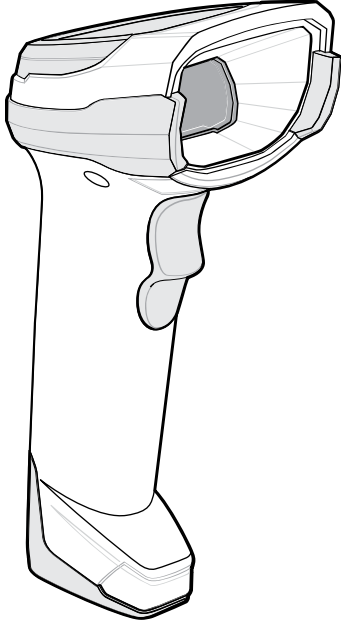

Refer to the DS8178 Digital Scanner Product Reference Guide for more information.



NOTE: To read a barcode, a scan-enabled app is required. The device contains the DataWedge app that allows the user to enable the scanner to decode barcode data and display the barcode content.

To scan with the DS8178 scanner:

1. Pair the scanner with the device. See [Pairing Bluetooth Scanners](#) for more information.
2. Ensure that an app is open on the device and a text field is in focus (text cursor in text field).
3. Point the scanner at a barcode.

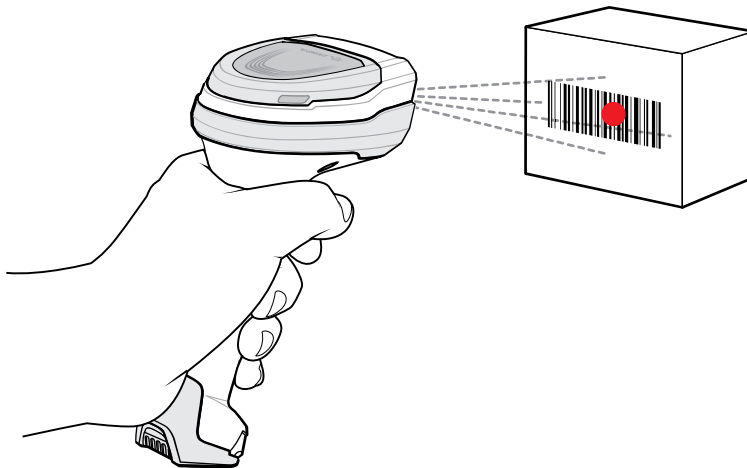

4. Press and hold the trigger.

5. Ensure the barcode is within the area formed by the aiming pattern. The aiming dot increases visibility in bright lighting conditions.

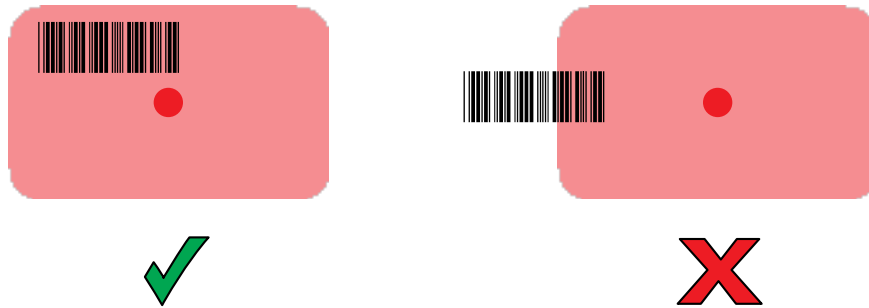

6. Upon successful decode, the scanner beeps and the LED flashes, and the scan line turns off. The captured data appears in the text field.

Scanning with the DS3678 Bluetooth Scanner

Use the DS3678 Bluetooth Scanner to capture barcode data.

Figure 23 DS3678 Digital Scanner

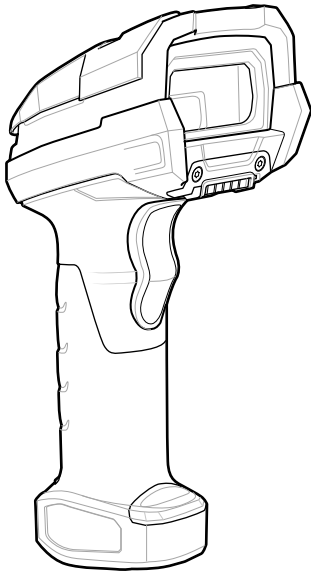

Refer to the DS3678 Product Reference Guide for more information.



NOTE: To read a barcode, a scan-enabled app is required. The device contains the DataWedge app that allows the user to enable the scanner to decode barcode data and display the barcode content.

To scan with the DS3678 scanner:

1. Pair the scanner with the device. See [Pairing Bluetooth Scanners](#) for more information.
2. Ensure that an app is open on the device and a text field is in focus (text cursor in text field).

3. Point the scanner at a barcode.

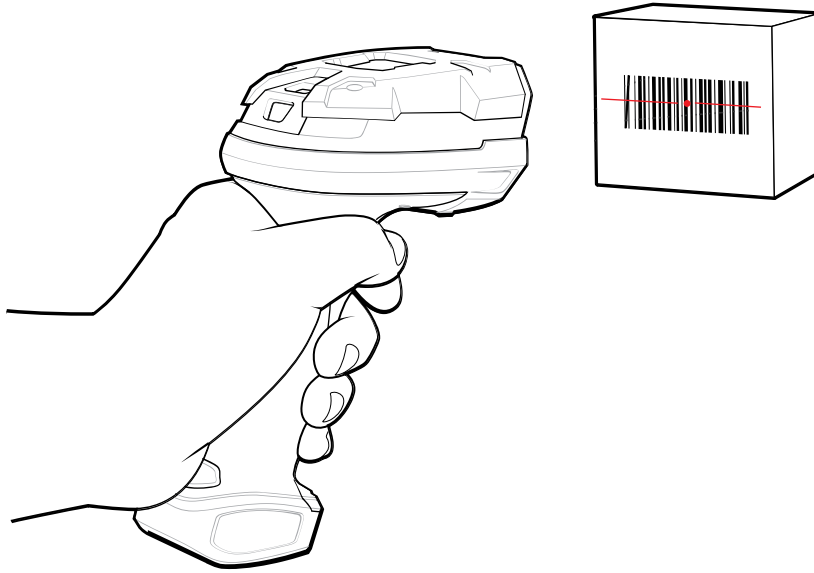

4. Press and hold the trigger.

Ensure the barcode is within the area formed by the aiming pattern. The aiming dot increases visibility in bright lighting conditions.

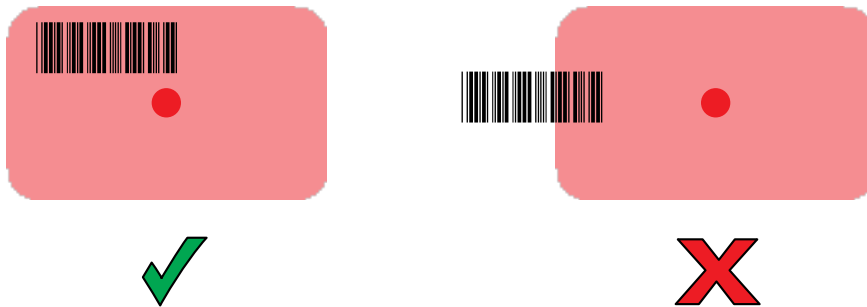

The captured data appears in the text field.

Scanning with the DS3608 USB Scanner

Use the DS3608 USB Scanner to capture barcode data.

Figure 24 DS3608 USB Scanner

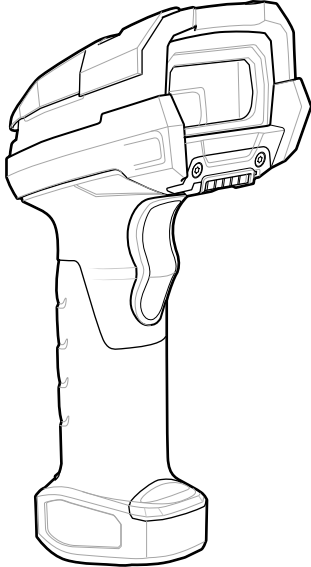

Refer to the DS3608 Product Reference Guide for more information.



NOTE: To read a barcode, a scan-enabled app is required. The device contains the DataWedge app that allows the user to enable the scanner to decode barcode data and display the barcode content.

To scan with the DS3608 scanner:

1. Connect the USB scanner to the device. See [Connecting a USB Scanner](#) for more information.
2. Ensure that an app is open on the device and a text field is in focus (text cursor in text field).
3. Point the scanner at a barcode.
4. Press and hold the trigger.

Ensure the barcode is within the area formed by the aiming pattern. The aiming dot increases visibility in bright lighting conditions.

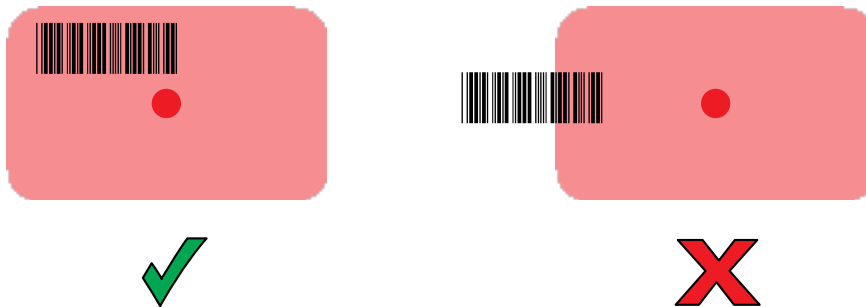

The captured data appears in the text field.

Scanning with the DS2278 Digital Scanner

Use the DS2278 Digital Scanner to capture barcode data.

Figure 25 DS2278 Digital Scanner



Refer to the DS2278 Digital Scanner Product Reference Guide for more information.



NOTE: To read a barcode, a scan-enabled app is required. The device contains the DataWedge app that allows the user to enable the scanner to decode barcode data and display the barcode content.

To scan with the DS2278:

1. Pair the DS2278 with the device. See [Pairing a Bluetooth Scanner](#) for more information.
2. Ensure that an app is open on the device and a text field is in focus (text cursor in text field).
3. Point the scanner at a barcode.

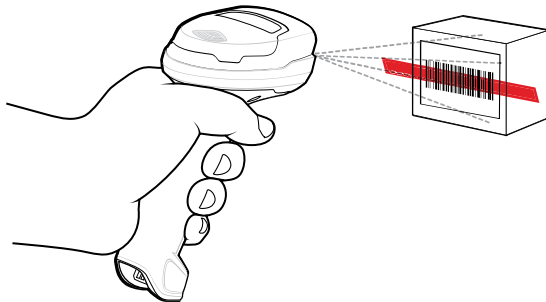

4. Press and hold the trigger.

5. Ensure the aiming pattern covers the barcode.



6. Upon successful decode, the scanner beeps and the LED flashes, and the scan line turns off. The captured data appears in the text field.

Pairing a Bluetooth Ring Scanner

Before using a Bluetooth Ring Scanner with the device, connect the device to the Ring Scanner.

To connect the Ring Scanner to the device, use one of the following methods:

- Near Field Communication (NFC)
- Simple Serial Interface (SSI)
- Bluetooth Human Interface Device (HID) Mode

Pairing in SSI Mode Using Near Field Communication

The device provides the ability to pair the RS5100/6100 or RS6000 Ring Scanner in SSI Mode using NFC.



NOTE: RS5100 or RS6000 Only.

1. Ensure that NFC is enabled on the device.
2. Align the NFC icon on the Ring Scanner with the NFC icon on the back of the device.

The Status LED blinks blue indicating that the Ring Scanner is attempting to establish a connection with the device. When a connection is established, the Status LED turns off and the Ring Scanner emits a single string of low/high beeps.

A notification appears on the device screen.

The  icon appears in the Status bar.

Pairing in HID Mode Using Near Field Communication

The device provides the ability to pair the RS6000 Ring Scanner in HID Mode using NFC. The device provides the ability to pair the RS5100/RS6100 or RS6000 Ring Scanner in HID Mode using NFC.



NOTE: NFC is supported on the premium configurations of the device.

Not all Zebra devices support NFC readers and the Tap-to-Pair feature.



NOTE: RS5100/RS6100 or RS6000 Only.

1. Ensure that NFC is enabled on the device.
2. Ensure that Bluetooth is enabled on both devices.
3. Ensure that the Bluetooth device to discover is in discoverable mode.
4. Ensure that the two devices are within 10 meters (32.8 feet) of one another.
5. Place the Ring Scanner in Human Interface Device (HID) mode. If the Ring Scanner is already in HID mode, skip to step 6.
 - a) Remove the battery from the Ring Scanner.
 - b) Press and hold the Restore key.
 - c) Install the battery onto the Ring Scanner.
 - d) Keep holding the Restore key for about five seconds until a chirp is heard and the Scan LEDs flash green.
 - e) Scan the barcode below to place the Ring Scanner in HID mode.

Figure 26 Bluetooth HID Barcode

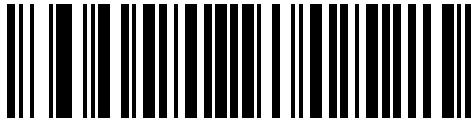

6. Remove the battery from the Ring Scanner.
7. Re-install the battery into the Ring Scanner.
8. Align the NFC icon on the Ring Scanner with the NFC icon on the device.

The Status LED blinks blue indicating that the Ring Scanner is attempting to establish a connection with the device. When a connection is established, the Status LED turns off and the Ring Scanner emits a single string of low/high beeps.

A notification appears on the device screen.

The **A** icon appears in the Status bar.

Pairing Using Simple Serial Interface (SSI)

Pair the Ring Scanner to the device using Simple Serial Interface.

1. Swipe up from the bottom of the Home screen and touch .
2. Using the Ring Scanner, scan the barcode on the screen.

The Ring Scanner emits a string of high/low/high/low beeps. The Scan LED flashes green indicating that the Ring Scanner is attempting to establish a connection with the device. When a connection is established, the Scan LED turns off and the Ring Scanner emits one string of low/high beeps.

A notification appears on the Notification panel and the  icon appears in the Status bar.

Pairing Using Bluetooth Human Interface Device

Pair the Bluetooth scanner to the device using HID.

To pair the scanner with the device using HID:

1. Remove the battery from the scanner.
2. Replace the battery.
3. After the scanner reboots, scan the barcode below to place the scanner in HID mode.



4. On the device, swipe down from the Status bar to open the Quick Access panel and then touch .
5. Touch **Bluetooth**.
6. Touch **Pair new device**. The device begins searching for discoverable Bluetooth devices in the area and displays them under **Available devices**.
7. Scroll through the list and select XXXXX xxxxxx, where XXXXX is the scanner and xxxxxx is the serial number.

The device connects to the scanner, the scanner beeps once and **Connected** appears below the device name. The Bluetooth device is added to the **Paired devices** list and a trusted (paired) connection is established.

Pairing a Bluetooth Scanner

Before using a Bluetooth scanner with the device, connect the device to the Bluetooth scanner.

Connect the scanner to the device using one of the following methods:

- Simple Serial Interface (SSI) mode
- Bluetooth Human Interface Device (HID) mode

Pairing Using Simple Serial Interface

Pair the Bluetooth scanner to the device using Simple Serial Interface (SSI).

1. Ensure that the two devices are within 10 meters (32.8 feet) of one another.
2. Install the battery into the scanner.

3. Swipe up from the bottom of the Home screen and touch .

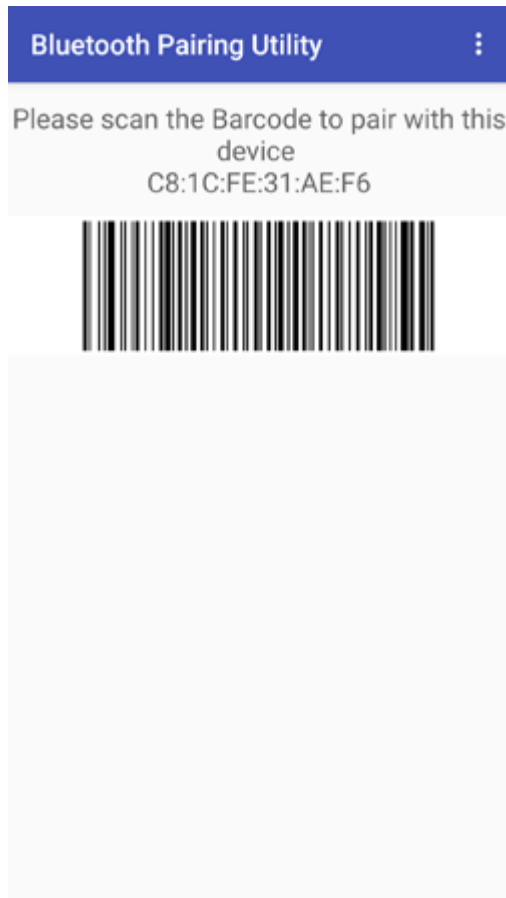

4. Using the Bluetooth scanner, scan the barcode on the screen.

The scanner emits a string of high/low/high/low beeps. The Scan LED flashes green indicating that the Ring Scanner is attempting to establish a connection with the device. When a connection is established, the Scan LED turns off and the Ring Scanner emits one string of low/high beeps.

A notification appears on the Notification panel and the  icon appears in the Status bar.

Pairing Using Bluetooth Human Interface Device

Pair the Bluetooth scanner to the device using HID.

To pair the scanner with the device using HID:

1. Remove the battery from the scanner.
2. Replace the battery.
3. After the scanner reboots, scan the barcode below to place the scanner in HID mode.

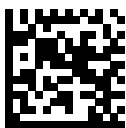

4. On the device, swipe down from the Status bar to open the Quick Access panel and then touch .

5. Touch **Bluetooth**.
6. Touch **Pair new device**. The device begins searching for discoverable Bluetooth devices in the area and displays them under **Available devices**.
7. Scroll through the list and select XXXXX xxxxxx, where XXXXX is the scanner and xxxxxx is the serial number.

The device connects to the scanner, the scanner beeps once and **Connected** appears below the device name. The Bluetooth device is added to the **Paired devices** list and a trusted (paired) connection is established.

DataWedge

DataWedge is a utility that adds advanced barcode scanning capability to any application without writing code. It runs in the background and handles the interface to built-in barcode scanners. The captured barcode data is converted to keystrokes and sent to the target application as if it was typed on the keypad.

DataWedge allows any app on the device to get data from input sources such as a barcode scanner, MSR, RFID, voice, or serial port and manipulate the data based on options or rules.



Configure DataWedge to:

- Provide data capture services from any app.
- Use a particular scanner, reader, or other peripheral devices.
- Properly format and transmit data to a specific app.

To configure DataWedge, refer to techdocs.zebra.com/datawedge/.

Enabling DataWedge



This procedure provides information on how to enable DataWedge on the device.

1. Swipe up from the bottom of the Home screen and touch .
2. Touch  > **Settings**.
3. Touch the **DataWedge enabled** checkbox.

A blue checkmark appears in the checkbox indicating that DataWedge is enabled.

Disabling DataWedge

This procedure provides information on how to disable DataWedge on the device.

1. Swipe up from the bottom of the Home screen and touch .
2. Touch .
3. Touch **Settings**.
4. Touch **DataWedge enabled**.

Supported Decoders

This sections provides the supported decoders for each data capture option.

Camera Supported Decoders

This section lists the supported decoders for the internal camera.

Table 12 Camera-Supported Decoders

Decoder	Default State	Decoder	Default State	Decoder	Default State
Australian Postal	O	EAN8	X	MSI	O
Aztec	X	Grid Matrix	O	PDF417	X
Canadian Postal	O	GS1 DataBar	X	QR Code	X
Chinese 2 of 5	O	GS1 DataBar Expanded	X	Decoder Signature	O
Codabar	X	GS1 DataBar Limited	O	TLC 39	O
Code 11	O	GS1 Datamatrix	O	Trioptic 39	O
Code 128	X	GS1 QRCode	O	UK Postal	O
Code 39	X	HAN XIN	O	UPCA	X
Code 93	O	Interleaved 2 of 5	O	UPCE0	X
Composite AB	O	Japanese Postal	O	UPCE1	O
Composite C	O	Korean 3 of 5	O	US4state	O
Discrete 2 of 5	O	MAIL MARK	X	US4state FICS	O
Datamatrix	X	Matrix 2 of 5	O	US Planet	O
Dutch Postal	O	Maxicode	X	US Postnet	O
DotCode	X	MicroPDF	O		
EAN13	X	MicroQR	O		

Key: X = Enabled, O = Disabled, - = Not Supported

SE4710 Internal Imager Supported Decoders

This section lists the supported decoders for the SE4710 internal imager.

Table 13 Internal Imager SE4710 Supported Decoders

Decoder	Default State	Decoder	Default State	Decoder	Default State
Australian Postal	O	EAN8	X	MSI	O

Table 13 Internal Imager SE4710 Supported Decoders (Continued)

Decoder	Default State	Decoder	Default State	Decoder	Default State
Aztec	X	Grid Matrix	O	PDF417	X
Canadian Postal	O	GS1 DataBar	X	QR Code	X
Chinese 2 of 5	O	GS1 DataBar Expanded	X	Decoder Signature	O
Codabar	X	GS1 DataBar Limited	O	TLC 39	O
Code 11	O	GS1 Datamatrix	O	Trioptic 39	O
Code 128	X	GS1 QRCode	O	UK Postal	O
Code 39	X	HAN XIN	O	UPCA	X
Code 93	O	Interleaved 2 of 5	O	UPCE0	X
Composite AB	O	Japanese Postal	O	UPCE1	O
Composite C	O	Korean 3 of 5	O	US4state	O
Discrete 2 of 5	O	MAIL MARK	X	US4state FICS	O
Datamatrix	X	Matrix 2 of 5	O	US Planet	O
Dutch Postal	O	Maxicode	X	US Postnet	O
DotCode	O	MicroPDF	O		
EAN13	X	MicroQR	O		

Key: X = Enabled, O = Disabled, - = Not Supported

SE55 Internal Imager Supported Decoders

This section lists the supported decoders for the SE55 internal imager.

Table 14 SE55 Internal Imager-Supported Decoders

Decoder	Default State	Decoder	Default State	Decoder	Default State
Australian Postal	O	EAN8	X	MSI	O
Aztec	X	Grid Matrix	O	PDF417	X
Canadian Postal	O	GS1 DataBar	X	QR Code	X
Chinese 2 of 5	O	GS1 DataBar Expanded	X	Decoder Signature	O
Codabar	X	GS1 DataBar Limited	O	TLC 39	O
Code 11	O	GS1 Datamatrix	O	Trioptic 39	O

Table 14 SE55 Internal Imager-Supported Decoders (Continued)

Decoder	Default State	Decoder	Default State	Decoder	Default State
Code 128	X	GS1 QRCode	O	UK Postal	O
Code 39	X	HAN XIN	O	UPCA	X
Code 93	O	Interleaved 2 of 5	O	UPCE0	X
Composite AB	O	Japanese Postal	O	UPCE1	O
Composite C	O	Korean 3 of 5	O	US4state	O
Discrete 2 of 5	O	MAIL MARK	X	US4state FICS	O
Datamatrix	X	Matrix 2 of 5	O	US Planet	O
Dutch Postal	O	Maxicode	X	US Postnet	O
DotCode	O	MicroPDF	O		
EAN13	X	MicroQR	O		

RS507/RS507x Supported Decoders

This section lists the supported decoders for the RS507/RS507x Ring Scanner.

Table 15 RS507/RS507x Supported Decoders

Decoder	Default State	Decoder	Default State	Decoder	Default State
Australian Postal	O	EAN8	X	MSI	O
Aztec	X	Grid Matrix	O	PDF417	X
Canadian Postal	-	GS1 DataBar	X	QR Code	X
Chinese 2 of 5	O	GS1 DataBar Expanded	X	Decoder Signature	O
Codabar	X	GS1 DataBar Limited	O	TLC 39	O
Code 11	O	GS1 Datamatrix	-	Trioptic 39	O
Code 128	X	GS1 QRCode	-	UK Postal	O
Code 39	O	HAN XIN	-	UPCA	X
Code 93	O	Interleaved 2 of 5	O	UPCE0	X
Composite AB	O	Japanese Postal	O	UPCE1	O
Composite C	O	Korean 3 of 5	O	US4state	O
Discrete 2 of 5	O	MAIL MARK	-	US4state FICS	O
Datamatrix	X	Matrix 2 of 5	O	US Planet	O

Table 15 RS507/RS507x Supported Decoders (Continued)

Decoder	Default State	Decoder	Default State	Decoder	Default State
Dutch Postal	O	Maxicode	X	US Postnet	O
DotCode	O	MicroPDF	O		
EAN13	X	MicroQR	O		

Key: X = Enabled, O = Disabled, - = Not Supported

RS5100 Supported Decoders

This section lists the supported decoders for the RS5100 Ring Scanner.

Table 16 RS5100-Supported Decoders

Decoder	Default State	Decoder	Default State	Decoder	Default State
Australian Postal	O	EAN8	X	MSI	O
Aztec	X	Grid Matrix	O	PDF417	X
Canadian Postal	O	GS1 DataBar	X	QR Code	X
Chinese 2 of 5	O	GS1 DataBar Expanded	X	Decoder Signature	O
Codabar	X	GS1 DataBar Limited	O	TLC 39	O
Code 11	O	GS1 Datamatrix	O	Trioptic 39	O
Code 128	X	GS1 QRCode	O	UK Postal	O
Code 39	X	HAN XIN	O	UPCA	X
Code 93	O	Interleaved 2 of 5	O	UPCE0	X
Composite AB	O	Japanese Postal	O	UPCE1	O
Composite C	O	Korean 3 of 5	O	US4state	O
Discrete 2 of 5	O	MAIL MARK	X	US4state FICS	O
Datamatrix	X	Matrix 2 of 5	O	US Planet	O
Dutch Postal	O	Maxicode	X	US Postnet	O
DotCode	O	MicroPDF	O		
EAN13	X	MicroQR	O		

Key: X = Enabled, O = Disabled, - = Not Supported

RS6000 Supported Decoders

This section lists the supported decoders for the RS6000 Ring Scanner.

Table 17 RS6000-Supported Decoders

Decoder	Default State	Decoder	Default State	Decoder	Default State
Australian Postal	O	EAN8	X	MSI	O
Aztec	X	Grid Matrix	O	PDF417	X
Canadian Postal	O	GS1 DataBar	X	QR Code	X
Chinese 2 of 5	O	GS1 DataBar Expanded	X	Decoder Signature	O
Codabar	X	GS1 DataBar Limited	O	TLC 39	O
Code 11	O	GS1 Datamatrix	O	Trioptic 39	O
Code 128	X	GS1 QRCode	O	UK Postal	O
Code 39	X	HAN XIN	O	UPCA	X
Code 93	O	Interleaved 2 of 5	O	UPCE0	X
Composite AB	O	Japanese Postal	O	UPCE1	O
Composite C	O	Korean 3 of 5	O	US4state	O
Discrete 2 of 5	O	MAIL MARK	X	US4state FICS	O
Datamatrix	X	Matrix 2 of 5	O	US Planet	O
Dutch Postal	O	Maxicode	X	US Postnet	O
DotCode	O	MicroPDF	O		
EAN13	X	MicroQR	O		

Key: X = Enabled, O = Disabled, - = Not Supported

RS6100 Supported Decoders

Lists the supported decoders for the RS6100 Ring Scanner.

Table 18 RS6100 Supported Decoders

Decoder	Default State	Decoder	Default State	Decoder	Default State
Australian Postal	O	EAN8	X	MSI	O
Aztec	X	Grid Matrix	O	PDF417	X
Canadian Postal	O	GS1 DataBar	X	QR Code	X

Table 18 RS6100 Supported Decoders (Continued)

Decoder	Default State	Decoder	Default State	Decoder	Default State
Chinese 2 of 5	O	GS1 DataBar Expanded	X	Decoder Signature	O
Codabar	X	GS1 DataBar Limited	O	TLC 39	O
Code 11	O	GS1 Datamatrix	O	Trioptic 39	O
Code 128	X	GS1 QRCode	O	UK Postal	O
Code 39	X	HAN XIN	O	UPCA	X
Code 93	O	Interleaved 2 of 5	O	UPCE0	X
Composite AB	O	Japanese Postal	O	UPCE1	O
Composite C	O	Korean 3 of 5	O	US4state	O
Discrete 2 of 5	O	MAIL MARK	X	US4state FICS	O
Datamatrix	X	Matrix 2 of 5	O	US Planet	O
Dutch Postal	O	Maxicode	X	US Postnet	O
DotCode	O	MicroPDF	O		
EAN13	X	MicroQR	O		

Key: X = Enabled, O = Disabled, - = Not Supported

LI3678 Supported Decoders

This section lists the supported decoders for the LI3678 scanner.

Table 19 LI3678-Supported Decoders

Decoder	Default State	Decoder	Default State	Decoder	Default State
Australian Postal	—	EAN8	X	MSI	O
Aztec	—	Grid Matrix	O	PDF417	—
Canadian Postal	—	GS1 DataBar	X	QR Code	—
Chinese 2 of 5	O	GS1 DataBar Expanded	X	Decoder Signature	—
Codabar	X	GS1 DataBar Limited	O	TLC 39	O
Code 11	O	GS1 Datamatrix	—	Trioptic 39	O
Code 128	X	GS1 QRCode	—	UK Postal	—
Code 39	X	HAN XIN	O	UPCA	X

Table 19 LI3678-Supported Decoders (Continued)

Decoder	Default State	Decoder	Default State	Decoder	Default State
Code 93	O	Interleaved 2 of 5	O	UPCE0	X
Composite AB	—	Japanese Postal	—	UPCE1	O
Composite C	—	Korean 3 of 5	O	US4state	—
Discrete 2 of 5	O	MAIL MARK	—	US4state FICS	—
Datamatrix	—	Matrix 2 of 5	O	US Planet	—
Dutch Postal	—	Maxicode	—	US Postnet	—
DotCode	O	MicroPDF	—		
EAN13	X	MicroQR	—		

Key: X = Enabled, O = Disabled, — = Not Supported

DS8178 Supported Decoders

This section lists the supported decoders for the DS8178 Digital scanner.

Table 20 DS8178 Digital Scanner-Supported Decoders

Decoder	Default State	Decoder	Default State	Decoder	Default State
Australian Postal	O	EAN8	X	MSI	O
Aztec	X	Grid Matrix	O	PDF417	X
Canadian Postal	—	GS1 DataBar	X	QR Code	X
Chinese 2 of 5	O	GS1 DataBar Expanded	X	Decoder Signature	—
Codabar	X	GS1 DataBar Limited	O	TLC 39	O
Code 11	O	GS1 Datamatrix	O	Trioptic 39	O
Code 128	X	GS1 QRCode	O	UK Postal	O
Code 39	X	HAN XIN	—	UPCA	X
Code 93	O	Interleaved 2 of 5	O	UPCE0	X
Composite AB	O	Japanese Postal	O	UPCE1	O
Composite C	O	Korean 3 of 5	O	US4state	O
Discrete 2 of 5	O	MAIL MARK	X	US4state FICS	O
Datamatrix	X	Matrix 2 of 5	O	US Planet	O
Dutch Postal	O	Maxicode	X	US Postnet	O

Table 20 DS8178 Digital Scanner-Supported Decoders (Continued)

Decoder	Default State	Decoder	Default State	Decoder	Default State
DotCode	O	MicroPDF	O		
EAN13	X	MicroQR	O		

Key: X = Enabled, O = Disabled, — = Not Supported

DS3678 Supported Decoders

This section lists the supported decoders for the DS3678 scanner.

Table 21 DS3678-Supported Decoders

Decoder	Default State	Decoder	Default State	Decoder	Default State
Australian Postal	O	EAN8	X	MSI	O
Aztec	X	Grid Matrix	O	PDF417	X
Canadian Postal	—	GS1 DataBar	X	QR Code	X
Chinese 2 of 5	O	GS1 DataBar Expanded	X	Decoder Signature	—
Codabar	X	GS1 DataBar Limited	O	TLC 39	O
Code 11	O	GS1 Datamatrix	O	Trioptic 39	O
Code 128	X	GS1 QRCode	O	UK Postal	O
Code 39	X	HAN XIN	O	UPCA	X
Code 93	O	Interleaved 2 of 5	O	UPCE0	X
Composite AB	O	Japanese Postal	O	UPCE1	O
Composite C	O	Korean 3 of 5	O	US4state	O
Discrete 2 of 5	O	MAIL MARK	X	US4state FICS	O
Datamatrix	X	Matrix 2 of 5	O	US Planet	O
Dutch Postal	O	Maxicode	X	US Postnet	O
DotCode	O	MicroPDF	O		
EAN13	X	MicroQR	O		

Key: X = Enabled, O = Disabled, — = Not Supported

DS3608 Supported Decoders

Lists the supported decoders for the DS3608 scanner.

Table 22 DS3608 Supported Decoders

Decoder	Default State	Decoder	Default State	Decoder	Default State
Australian Postal	O	EAN8	X	MSI	O
Aztec	X	Grid Matrix	O	PDF417	X
Canadian Postal	—	GS1 DataBar	X	QR Code	X
Chinese 2 of 5	O	GS1 DataBar Expanded	X	Decoder Signature	—
Codabar	X	GS1 DataBar Limited	O	TLC 39	O
Code 11	O	GS1 Datamatrix	O	Trioptic 39	O
Code 128	X	GS1 QRCode	O	UK Postal	O
Code 39	X	HAN XIN	O	UPCA	X
Code 93	O	Interleaved 2 of 5	O	UPCE0	X
Composite AB	O	Japanese Postal	O	UPCE1	O
Composite C	O	Korean 3 of 5	O	US4state	O
Discrete 2 of 5	O	MAIL MARK	X	US4state FICS	O
Datamatrix	X	Matrix 2 of 5	O	US Planet	O
Dutch Postal	O	Maxicode	X	US Postnet	O
DotCode	O	MicroPDF	O		
EAN13	X	MicroQR	O		

Key: X = Enabled, O = Disabled, — = Not Supported

DS2278 Supported Decoders

This section lists the supported decoders for the DS2278 Digital Scanner.

Table 23 DS2278 Digital Scanner-Supported Decoders

Decoder	Default State	Decoder	Default State	Decoder	Default State
Australian Postal	O	EAN8	X	MSI	O
Aztec	X	Grid Matrix	O	PDF417	X
Canadian Postal	—	GS1 DataBar	X	QR Code	X

Table 23 DS2278 Digital Scanner-Supported Decoders (Continued)

Decoder	Default State	Decoder	Default State	Decoder	Default State
Chinese 2 of 5	O	GS1 DataBar Expanded	X	Decoder Signature	O
Codabar	X	GS1 DataBar Limited	O	TLC 39	O
Code 11	O	GS1 Datamatrix	O	Trioptic 39	O
Code 128	X	GS1 QRCode	O	UK Postal	O
Code 39	X	HAN XIN	—	UPCA	X
Code 93	O	Interleaved 2 of 5	O	UPCE0	X
Composite AB	O	Japanese Postal	O	UPCE1	O
Composite C	O	Korean 3 of 5	O	US4state	O
Discrete 2 of 5	O	MAIL MARK	X	US4state FICS	O
Datamatrix	X	Matrix 2 of 5	O	US Planet	O
Dutch Postal	O	Maxicode	X	US Postnet	O
DotCode	O	MicroPDF	O		
EAN13	X	MicroQR	O		

Key: X = Enabled, O = Disabled, — = Not Supported

Wireless

This section provides information on the wireless features of the device.

The following wireless features are available on the device:

- Wireless Wide Area Network (WWAN)
- Wireless Local Area Network (WLAN)
- Bluetooth
- Cast
- Near Field Communications (NFC)

Wireless Wide Area Networks

Use wireless wide area networks (WWANs) to access data over a cellular network.



NOTE: Applies to WWAN devices only.

This section provides information on:

- Sharing a data connection.
- Monitoring data usage.
- Changing cellular network settings.

Sharing the Mobile Data Connection

The **Tethering & Portable Hotspot** settings allow sharing the mobile data connection with a single computer via USB tethering or Bluetooth tethering.

Share the data connection with up to eight devices at once, by turning it into a portable Wi-Fi hotspot. While the device is sharing its data connection, an icon displays at the top of the screen and a corresponding message appears in the notification list.

Enabling USB Tethering



NOTE: USB tethering is not supported on computers running Mac OS. If the computer is running Windows or a recent version of Linux (such as Ubuntu), follow these instructions without any special preparation. If running a version of Windows that precedes Windows 7, or some other

operating system, you may need to prepare the computer to establish a network connection via USB.

1. Connect the device to a host computer with a USB cable.

The notification **Charging this device via USB** appears in the Notifications panel.

2. Go to **Settings**.
3. Touch **Network & Internet**.
4. Touch **Hotspot & tethering**.
5. Touch the **USB tethering** switch to enable.

The host computer is now sharing the device's data connection.

To stop sharing the data connection, touch the **USB tethering** switch again or disconnect the USB cable.

Enabling Bluetooth Tethering

Use Bluetooth tethering to share the data connection with a host computer.

Configure the host computer to obtain its network connection using Bluetooth. For more information, see the host computer's documentation.

1. Pair the device with the host computer.
2. Go to **Settings**.
3. Touch **Networking & internet > Hotspot & tethering**.
4. Touch the **Bluetooth tethering** switch to enable.

The host computer is now sharing the device's data connection.

To stop sharing the data connection, touch the **Bluetooth tethering** switch again.

Enabling Wi-Fi Hotspot

After configuring the device as a Wi-Fi Hotspot, turn on Wi-Fi Hotspot to begin using it.

1. Go to **Settings**.
2. Touch **Networking & Internet**.
3. Touch **Hotspot & tethering**.
4. Touch **Wi-Fi hotspot**.
5. Toggle the switch to enable.

After a moment, the device starts broadcasting its Wi-Fi network name (SSID). Connect to it with up to eight computers or other devices. The Hotspot (📶) icon appears in the Status bar.

To stop sharing the data connection, touch the toggle switch again.

Configuring the Wi-Fi Hotspot

Set up a Wi-Fi hotspot on the device

1. Go to **Settings**.
2. Touch **Networking & Internet**.

3. Touch **Hotspot & tethering**.
4. Touch **Wi-Fi hotspot**.
5. In the **Hotspot** name text field, edit the name for the hotspot.
6. Touch **Security** and select a security method from the drop-down list.
 - **WPA3-Personal**
 - a. Touch **Hotspot password**.
 - b. Enter a password.
 - c. Touch **OK**.
 - **WPA2/WPA3-Personal**
 - a. Touch **Hotspot password**.
 - b. Enter a password.
 - c. Touch **OK**.
 - **WPA2-Personal**
 - a. Touch **Hotspot password**.
 - b. Enter a password.
 - c. Touch **OK**.
 - **None** - If **None** is selected in the Security option, a password is not required.
7. Touch **Advanced**.
8. In the **AP Band** drop-down list, select **2.4 GHz Band** or **5.0 GHz Band**.
9. If desired, touch **Turn off hotspot automatically** to turn off Wi-Fi Hotspot when no devices are connected.

Data Usage

Data usage refers to the amount of data uploaded or downloaded by the device during a given period. Depending on the wireless plan, you may be charged additional fees when your data usage exceeds your plan's limit.

Data usage settings allow you to:

- Enable Data Saver.
- Set the data usage warning level.
- Set a data usage limit.
- View or restrict data usage by app.
- Identify mobile hotspots and restrict background downloads that may result in extra charges.

Monitoring Data Usage

Data usage is how much data the device uploads or downloads using a cellular network. To make sure that you are not using too much data, check and change your data usage.



CAUTION: . Your carrier's data usage accounting may differ. Usage in excess of your carrier plan's data limits can result in steep overage charges. The feature described here can help you track your usage but is not guaranteed to prevent additional charges.

1. Go to **Settings**.
2. Touch **Network & internet**.
3. Touch **Internet**.
4. Touch .

The data usage graph displays.

Setting Data Usage Warning

Set a warning alert when the device has used a certain amount of mobile data.

1. Go to **Settings**.
2. Touch **Network & Internet > Mobile Network > Data warning & limit > Mobile data usage cycle**.
3. If necessary, touch **Set data warning** to enable it.
4. Touch **Data warning**.
5. Enter a number.

To switch between megabytes (MB) and gigabytes (GB), touch the down arrow.

6. Touch **SET**.

When the data usage reaches the set level, a notification appears.

Setting Data Limit

Set data limits to ensure that you do not go over your data plan limit.

1. Go to **Settings**.
2. Touch **Network & Internet > Mobile Network > Data warning & limit > Mobile data usage cycle**.
3. Touch **Set data limit**.

A message displays stating that the phone will turn off mobile data once it reaches the limit you set.

4. Touch **OK**.
5. Touch **Data limit**.
6. Enter a number.

To switch between megabytes (MB) and gigabytes (GB), touch the down arrow.

7. Touch **SET**.

Cellular Network Settings

Cellular network settings applies to WWAN devices only.

Data When Roaming



Roaming is disabled by default to prevent the device from transmitting data over other carriers' mobile networks when leaving an area that is covered by the carrier's networks. This is useful for controlling expenses if the service plan does not include data roaming.

Configuring the Access Point Name

To use the data on a network, configure the APN information.



NOTE: Many service provider Access Point Name (APN) data are pre-configured in the device. The wireless service provider must obtain the APN information for all other service providers.

1. Go to **Settings**.
2. Touch **Network & internet**.
3. Touch **Internet**.
4. Touch .
5. Touch **Data warning & limit**.
6. Touch **Access Point Names**.
7. Touch an APN name in the list to edit an existing APN or touch + to create a new APN.
8. Touch each APN setting and enter the appropriate data obtained from the wireless service provider.
9. When finished, touch  > **Save**.
10. Touch the radio button next to the APN name to start using it.

Locking the SIM Card

Locking the SIM card requires the user to enter a PIN every time the device is turned on. Only emergency calls can be made if the correct PIN is not entered.

1. Go to **Settings**.
2. Touch **Security**.
3. Touch **More security settings**.
4. Touch **SIM card lock**.
5. Touch **Lock SIM card**.
6. Enter the PIN associated with the card.
7. Touch **OK**.
8. Reset the device.

Activating an eSIM

The TC27 can use a SIM card, an eSIM, or both. You can choose which SIM to use for which action, such as messaging or calling. Before using it, you must activate the eSIM.



NOTE: Prior to adding an eSIM, contact your carrier to obtain the eSIM service and its activation code or QR code.

1. On the device, establish an internet connection via Wi-Fi or cellular data with an installed SIM card.
2. Go to **Settings**.
3. Touch **Network & internet > Mobile Networks**.
4. Touch + next to **SIMs** if a SIM card is already installed or touch **SIMs** if there is no SIM card installed.

The **Mobile network** screen displays.

5. Select **MANUAL CODE ENTRY** to enter the activation code or touch **SCAN** to scan the QR code to download the eSIM profile.

The **Confirmation!!!** dialog box displays.

6. Touch **OK**.
7. Enter the activation code or scan the QR Code.
8. Touch **NEXT**.

The **Downloading a profile** message displays followed by **Use Network Name?** message.

9. Touch **ACTIVATE**.
10. Touch **Done**.

The eSIM is now active.

Deactivating an eSIM

Turn off an eSIM temporarily and re-activate it later

1. On the device, establish an internet connection via Wi-Fi or cellular data with an installed SIM card.
2. Touch **Network & internet > SIMs**.
3. In the **Download SIM** section, touch the eSIM to deactivate.
4. Touch **Use SIM** switch to turn off the eSIM.
5. Touch **Yes**.

The eSIM is deactivated.

Erasing an eSIM Profile

Erasing an eSIM profile removes it completely from the device.



NOTE: After erasing an eSIM from the device, you cannot use it again.

1. On the device, establish an internet connection via Wi-Fi or cellular data with an installed SIM card.
2. Touch **Network & internet > SIMs**.
3. In the **Download SIM** section, touch the eSim to erase.

4. Touch **Erase**.

The **Erase this downloaded SIM?** message displays.

5. Touch **Erase**.

The eSIM profile is erased from the device.

Wireless Local Area Networks

Wireless local area networks (WLANs) allow the device to communicate wirelessly inside a building. Before using the device on a WLAN, the facility must be set up with the required hardware to run the WLAN (sometimes known as infrastructure). The infrastructure and the device must both be properly configured to enable this communication.



NOTE: To extend the life of the battery, turn off Wi-Fi when not in use.

Refer to the documentation provided with the infrastructure [access points (APs), access ports, switches, Radius servers, etc.] on set up. When the infrastructure is set up to enforce the chosen WLAN security scheme, use the **Network & internet** settings to configure the device to match the security scheme.

Connecting to a Wi-Fi Network

This section describes how to connect to a Wi-Fi network.

1. Go to **Settings**.

2. Touch **Network & internet > Internet**.

The **Internet** screen displays, and the device searches for WLANs in the area and lists them.

3. Scroll through the list and select the desired WLAN network.

4. For open networks, touch the profile (or press and hold) and select **Connect**. For secure networks, enter the required password or other credentials and then touch **Connect**. See the system administrator for more information.

The device obtains a network address and other required information from the network using the dynamic host configuration protocol (DHCP) protocol. To configure the device with a fixed internet protocol (IP) address, see [Configuring the Device to Use a Static IP Address](#).

In the Wi-Fi setting field, **Connected** displays, indicating that the device is connected to the WLAN.

Wi-Fi Version

When the device is connected to a Wi-Fi network, the Wi-Fi icon on the Status bar indicates the Wi-Fi network version.

Table 24 Wi-Fi Version Icons

Icon	Description
	Connected to Wi-Fi 6, the 802.11ax standard.
	Connected to Wi-Fi 5, the 802.11ac standard.

Table 24 Wi-Fi Version Icons (Continued)

Icon	Description
	Connected to Wi-Fi 4, the 802.11n standard.

Removing a Wi-Fi Network

This section describes how to remove a Wi-Fi network.

1. Go to **Settings**.
2. Touch **Network & internet** > **Internet**.
3. Scroll down to the bottom of the list and touch **Saved networks**.
4. Touch the name of the network.
5. Touch **FORGET**.

The device automatically disconnects from the Wi-Fi network.

WLAN Configuration

This section provides information on configuring Wi-Fi settings.

Configuring a Secure Wi-Fi Network

1. Go to **Settings**.
2. Touch **Network & internet** > **Internet**.
3. Turn on the **Wi-Fi** switch.
The device searches for WLANs in the area and lists them on the screen.
4. Scroll through the list and select the desired WLAN network.
5. Touch the desired network. If network security is **None**, the device automatically connects to the network. For all other network security, a dialog box appears.
6. If network security is **WPA/WPA2-Personal**, **WPA3-Personal**, or **WEP**, enter the required password, and then touch **Connect**.

7. If network security is WPA/WPA2/WPA3 Enterprise:

a) Touch the **EAP method** drop-down list and select one of the following:

- **PEAP**
- **TLS**
- **TTLS**
- **PWD**
- **SIM**
- **AKA**
- **AKA'**
- **LEAP**

b) Fill in the appropriate information. Options vary depending on the **EAP method** chosen.

- When selecting **CA certificate**, Certification Authority (CA) certificates are installed using the **Security** settings.
- When using the EAP methods PEAP, TLS, or TTLS, specify a domain.
- Touch **Advanced options** to display additional network options.

Manually Adding a Wi-Fi Network

Manually add a Wi-Fi network if the network does not broadcast its name (SSID) or to add a Wi-Fi network when out of range.

1. Go to **Settings**.
2. Touch **Network & internet > Internet**.
3. Turn on the **Wi-Fi** switch.
4. Scroll to the bottom of the list and select **Add network**.
5. In the **Network name** text box, enter the name of the Wi-Fi network.
6. In the **Security** drop-down list, set the type of security to:
 - **None**
 - **Enhanced Open**
 - **WEP**
 - **WPA/WPA2-Personal**
 - **WPA3-Personal**
 - **WPA/WPA2-Enterprise**
 - **WPA3-Enterprise**
 - **WPA3-Enterprise 192-bit**
7. If the network security is **None** or **Enhanced Open**, touch **Save**.
8. If the network security is **WEP**, **WPA3-Personal**, or **WPA/WPA2-Personal**, enter the required password and then touch **Save**.



NOTE: By default, the network Proxy is set to **None** and the IP settings are set to **DHCP**. See [Configuring for a Proxy Server](#) and [Configuring the Device to Use a Static IP Address](#).

9. If network security is **WPA/WPA2/WPA3 Enterprise**:
 - a) Touch the **EAP method** drop-down list and select one of the following:
 - **PEAP**
 - **TLS**
 - **TTLS**
 - **PWD**
 - **SIM**
 - **AKA**
 - **AKA'**
 - **LEAP**
 - b) Fill in the appropriate information. Options vary depending on the selected **EAP method**
 - When selecting **CA certificate**, Certification Authority (CA) certificates are installed using the **Security** settings.
 - When using the EAP methods PEAP, TLS, or TTLS, specify a domain.
 - Touch **Advanced options** to display additional network options.
10. If the network security is WPA3-Enterprise 192-bit:
 - Touch **CA certificate** and select a Certification Authority (CA) certificate. Note: Certificates are installed using the Security settings.
 - Touch **User certificate** and select a user certificate. Note: User certificates are installed using the Security settings.
 - In the **Identity** text box, enter the username credentials.
11. Touch **Save**. To connect to the saved network, touch and hold on the saved network and select **Connect to network**.

Configuring a Proxy Server

A proxy server is a server that acts as an intermediary for requests from clients seeking resources from other servers. A client connects to the proxy server and requests some service, such as a file, connection, web page, or other resource, available from a different server. The proxy server evaluates the request according to its filtering rules. For example, it may filter traffic by IP address or protocol. If the request is validated by the filter, the proxy provides the resource by connecting to the relevant server and requesting the service on behalf of the client.

Enterprise customers must set up secure computing environments within their companies, making proxy configuration essential. Proxy configuration acts as a security barrier, ensuring the proxy server monitors all traffic between the internet and intranet traffic. This is normally an integral part of security enforcement in corporate firewalls within intranets.

1. Go to **Settings**.
2. Touch **Network & internet** > **Internet**.
3. Turn on the **Wi-Fi** switch.

4. In the network dialog box, select and touch a network.
5. If configuring the connected network, touch  to edit the network details and then touch the down arrow to hide the keyboard.
6. Touch **Advanced options**.
7. Touch **Proxy** and select **Manual**.
8. In the **Proxy hostname** text box, enter the address of the proxy server.
9. In the **Proxy port** text box, enter the port number for the proxy server.
10. In the **Bypass proxy for** text box, enter addresses for websites that are not required to go through the proxy server. Use a comma “,” between addresses. Do not use spaces or carriage returns between addresses.
11. If configuring the connected network, touch **Save** otherwise, touch **Connect**.

Configuring the Device to Use a Static IP Address

By default, the device is configured to use Dynamic Host Configuration Protocol (DHCP) to assign an Internet protocol (IP) address when connecting to a wireless network.

1. Go to **Settings**.
2. Touch **Network & internet** > **Internet**.
3. Turn on the **Wi-Fi** switch.
4. In the network dialog box, select and touch a network.
5. If you are configuring the connected network, touch  to edit the network details and then touch the down arrow to hide the keyboard.
6. Touch **Advanced options**.
7. Touch **IP settings** and select **Static**.
8. In the **IP address** text box, enter an IP address for the device.
9. If required:
 - In the **Gateway** text box, enter a gateway address for the device.
 - In the **Network prefix length** text box, enter the prefix length.
 - In the **DNS 1** text box, enter a Domain Name System (DNS) address.
 - In the **DNS 2** text box, enter a DNS address.
10. If you are configuring the connected network, touch **Save** otherwise, touch **Connect**.

Wi-Fi Preferences

Use the Wi-Fi preferences to configure advanced Wi-Fi settings.

From the **Internet** screen, scroll down and touch **Network preferences**.

- **Turn on Wi-Fi automatically** - When enabled, Wi-Fi automatically turns back on when near high-quality saved networks.
- **Notify for public networks** - When enabled, it notifies you when a public network is available.
- **Additional settings** - Touch to view additional Wi-Fi settings.

- **Install Certificates** - Touch to install certificates.
- **Wi-Fi Direct**- Displays a list of devices available for a direct Wi-Fi connection.

Additional Wi-Fi Settings

Use the Additional Settings to configure additional Wi-Fi settings. To view the additional Wi-Fi settings, scroll to the bottom of the Internet screen and touch **Network Preferences > Additional settings**.



NOTE: Additional Wi-Fi settings are for the device, not for a specific wireless network.

- **Regulatory**
 - **Country Selection** - Displays the acquired country code if 802.11d is enabled, else it displays the currently selected country code.
 - **Region code** - Displays the current region code.
- **Band and Channel Selection**
 - **Wi-Fi frequency band** - Set the frequency band to: **Auto** (default), **5 GHz only** or **2.4 GHz only**.
 - **Available channels (2.4 GHz)** - Touch to display the **Available channels** menu. Select specific channels and touch **OK**. Only available with mDNA Enterprise Bundle upgrade.
 - **Available channels (5 GHz)** - Touch to display the **Available channels** menu. Select specific channels and touch **OK**.
 - **Available channels (6 GHz)** - Touch to display the **Available channels** menu. Select specific channels and touch **OK**. Only available with mDNA Enterprise Bundle upgrade.
- **Logging**
 - **Advanced Logging** – Touch to enable advanced logging, verbose logging, or change the log directory.
 - **Wireless logs** - Use to capture Wi-Fi log files.
 - **Fusion Logger** - Touch to open the **Fusion Logger** application. This application maintains a history of high level WLAN events which helps to understand the status of connectivity. Only available with mDNA Enterprise Bundle upgrade.
 - **Fusion Status** - Touch to display live status of WLAN state. Also provides information about the device and connected profile. Only available with mDNA Enterprise Bundle upgrade.

Wi-Fi Direct

Wi-Fi Direct devices can connect to each other without having to go through an access point. Wi-Fi Direct devices establish their own ad-hoc network when required, letting you see which devices are available and choose which one to connect to.

To view available devices and connect to a device:

1. Go to **Settings**.
2. Touch **Network & internet > Internet**.
3. Slide the **Wi-Fi** switch to the **On** position.
4. Scroll down to the bottom of the screen and touch **Network preferences > Wi-Fi Direct**.
5. Under **Peer devices**, touch a device's name.

6. On the other device, select **Accept**.

Connected displays on the device. On both devices, on their respective Wi-Fi Direct screens, the other device name displays in the list.

Bluetooth

Bluetooth devices can communicate without wires, using frequency-hopping spread spectrum (FHSS) radio frequency (RF) to transmit and receive data in the 2.4 GHz Industry Scientific and Medical (ISM) band (802.15.1). Bluetooth wireless technology is specifically designed for short-range (10 m (32.8 ft)) communication and low power consumption.

Devices with Bluetooth capabilities can exchange information (for example, files, appointments, and tasks) with other Bluetooth enabled devices such as printers, access points, and other mobile devices.

The device supports Bluetooth Low Energy. Bluetooth Low Energy is targeted at applications in the healthcare, fitness, security, and home entertainment industries. It provides reduced power consumption and cost while maintaining standard Bluetooth range.

Adaptive Frequency Hopping

Adaptive Frequency Hopping (AFH) is a method of avoiding fixed frequency interferers, and can be used with Bluetooth voice. All devices in the piconet (Bluetooth network) must be AFH-capable in order for AFH to work. There is no AFH when connecting and discovering devices. Avoid making Bluetooth connections and discoveries during critical 802.11b communications.

AFH for Bluetooth consists of four main sections:

- Channel Classification - A method of detecting an interference on a channel-by-channel basis, or pre-defined channel mask.
- Link Management - Coordinates and distributes the AFH information to the rest of the Bluetooth network.
- Hop Sequence Modification - Avoids interference by selectively reducing the number of hopping channels.
- Channel Maintenance - A method for periodically re-evaluating the channels.

When AFH is enabled, the Bluetooth radio “hops around” (instead of through) the 802.11b high-rate channels. AFH coexistence allows enterprise devices to operate in any infrastructure.

The Bluetooth radio in this device operates as a Class 2 device power class. The maximum output power is 2.5 mW and the expected range is 10 m (32.8 ft). A definition of ranges based on power class is difficult to obtain due to power and device differences, and whether in open space or closed office space.



NOTE: It is not recommended to perform Bluetooth wireless technology inquiry when high rate 802.11b operation is required.

Security

The current Bluetooth specification defines security at the link level. Application-level security is not specified. This allows application developers to define security mechanisms tailored to their specific needs. Link-level security occurs between devices, not users, while application-level security can be implemented on a per-user basis. The Bluetooth specification defines security algorithms and procedures required to authenticate devices, and if needed, encrypt the data flowing on the link between the devices. Device authentication is a mandatory feature of Bluetooth while link encryption is optional.

Pairing of Bluetooth devices is accomplished by creating an initialization key used to authenticate the devices and create a link key for them. Entering a common personal identification number (PIN) in the devices being paired generates the initialization key. The PIN is never sent over the air. By default, the Bluetooth stack responds with no key when a key is requested (it is up to the user to respond to the key request event). Authentication of Bluetooth devices is based upon a challenge-response transaction. Bluetooth allows for a PIN or passkey used to create other 128-bit keys used for security and encryption. The encryption key is derived from the link key used to authenticate the pairing devices. Also, the limited range and fast frequency hopping of the Bluetooth radios make long-distance eavesdropping difficult.

Recommendations are:

- Perform pairing in a secure environment.
- Keep PIN codes private and do not store the PIN codes in the device.
- Implement application-level security.

Bluetooth Profiles

The device supports the Bluetooth services listed.

Table 25 Bluetooth Profiles

Profile	Description
Service Discovery Protocol (SDP)	Handles the search for known and specific services as well as general services.
Serial Port Profile (SPP)	Allows use of RFCOMM protocol to emulate serial cable connection between two Bluetooth peer devices. For example, connecting the device to a printer.
Object Push Profile (OPP)	Allows the device to push and pull objects to and from a push server.
Advanced Audio Distribution Profile (A2DP)	Allows the device to stream stereo-quality audio to a wireless headset or wireless stereo speakers.
Audio/Video Remote Control Profile (AVRCP)	Allows the device to control A/V equipment to which a user has access. It may be used in concert with A2DP.
Personal Area Network (PAN)	Allows the use of Bluetooth Network Encapsulation Protocol to provide L3 networking capabilities over a Bluetooth link. Only PANU role is supported.
Human Interface Device Profile (HID)	Allows Bluetooth keyboards, pointing devices, gaming devices and remote monitoring devices to connect to the device.
Headset Profile (HSP)	Allows a hands-free device, such as a Bluetooth headset, to place and receive calls on the device.
Hands-Free Profile (HFP)	Allows car hands-free kits to communicate with the device in the car.
Phone Book Access Profile (PBAP)	Allows exchange of Phone Book Objects between a car kit and a mobile device to allow the car kit to display the name of the incoming caller; allow the car kit to download the phone book so you can initiate a call from the car display.

Table 25 Bluetooth Profiles (Continued)

Profile	Description
Out of Band (OOB)	Allows exchange of information used in the pairing process. Pairing is completed using the Bluetooth radio, but requires information from the OOB mechanism. Using OOB with NFC enables pairing when devices simply get close, rather than requiring a lengthy discovery process.
Out of Band (OOB)	Allows exchange of information used in the pairing process. Pairing is initiated by NFC but completed using the Bluetooth radio. Pairing requires information from the OOB mechanism. Using OOB with NFC enables pairing when devices simply get close, rather than requiring a lengthy discovery process.
Out of Band (OOB)	Allows exchange of information used in the pairing process. Pairing is completed using the Bluetooth radio, but requires information from the OOB mechanism.
Symbol Serial Interface (SSI)	Allows for communication with Bluetooth Imager.
File Transfer Profile (FTP)	Provides the capability to browse, manipulate and transfer files in file system of another system. Uses GOEP as a basis.
Generic Attribute Profile (GATT)	Provides profile discovery and description services for Bluetooth Low Energy protocol. It defines how attributes are grouped together into sets to form services.
HID Over GATT Profile (HOGP)	Defines the procedures and features used by Bluetooth low energy HID Devices using GATT and Bluetooth HID Hosts using GATT.
Scan Parameters Profile (ScPP)	Provides devices with information to assist them in managing their connection idle timeout and advertising parameters to optimize for power consumption and/or reconnection latency.
Dial Up Networking (DUN)	Provides a standard to access the Internet and other dial-up services over Bluetooth.
Generic Access Profile (GAP)	Use for device discovery and authentication.
Object EXchange (OBEX)	Facilitates the exchange of binary objects between devices.

Bluetooth Power States

The Bluetooth radio is off by default.

- **Suspend** - When the device goes into Sleep mode, the Bluetooth radio stays on.
- **Airplane Mode** - When the device is placed in Airplane Mode, the Bluetooth radio is not turned off when the device is connected to a Bluetooth headset or hearing device.

Bluetooth Radio Power

Turn off the Bluetooth radio to save power or if entering an area with radio restrictions (for example, an airplane). When the radio is off, other Bluetooth devices cannot see or connect to the device. Turn on the Bluetooth radio to exchange information with other Bluetooth devices (within range). Communicate only with Bluetooth radios in close proximity.



NOTE: To achieve optimal battery life, turn off radios when not in use.

Enabling Bluetooth

1. Swipe down from the Status bar to open the Notification panel.
2. Touch  to turn Bluetooth on.

Disabling Bluetooth

1. Swipe down from the Status bar to open the Notification panel.
2. Touch  to turn Bluetooth off.

Discovering Bluetooth Device(s)

The device can receive information from discovered devices without pairing. However, once paired, the device and a paired device exchange information automatically when the Bluetooth radio is on.

1. Ensure that Bluetooth is enabled on both devices.
2. Ensure that the Bluetooth device to discover is in discoverable mode.
3. Ensure that the two devices are within 10 m (32.8 ft) of one another.
4. Swipe down from the Status bar to open the Quick Access panel.
5. Touch and hold **Bluetooth**.
6. Touch **Pair new device**. The device begins searching for discoverable Bluetooth devices in the area and displays them under **Available devices**.
7. Scroll through the list and select a device. The Bluetooth pairing request dialog box appears.
8. Touch **Pair** on both devices.
9. The Bluetooth device is added to the **Paired devices** list and a trusted (“paired”) connection is established.

Changing the Device's Bluetooth Name

By default, the device has a generic Bluetooth name that is visible to other devices when connected.

1. Go to **Settings**.
2. Touch **Connected devices** > **Connection preferences** > **Bluetooth**.
3. If Bluetooth is not on, move the switch to turn Bluetooth on.
4. Touch **Device name**.
5. Enter a name and touch **RENAME**.

Connecting to a Bluetooth Device

Once paired, connect to a Bluetooth device.

1. Go to **Settings**.
2. Touch **Connected devices** > **Connection preferences** > **Bluetooth**.
3. In the list, touch the unconnected Bluetooth device.

When connected, **Connected** appears below the device name.

Selecting Profiles on the Bluetooth Device

Some Bluetooth devices have multiple profiles.

1. Go to **Settings**.
2. Touch **Connected devices** > **Connection preferences** > **Bluetooth**.
3. In the **Paired Devices** list, touch  next to the device name.
4. Turn on or off a profile to allow the device to use that profile.

Unpairing a Bluetooth Device

Unpairing a Bluetooth device erases all pairing information.

1. Go to **Settings**.
2. Touch **Connected devices** > **Connection preferences** > **Bluetooth**.
3. In the **Paired Devices** list, touch  next to the device name.
4. Touch **FORGET**.

Cast

Use **Cast** to mirror the device screen on a Miracast enabled wireless display.

1. Go to **Settings**.
2. Touch **Connected devices** > **Connection preferences** > **Cast**.
3. Touch  > **Enable wireless display**.
The device searches for nearby Miracast devices and lists them.
4. Touch a device to begin casting.

Near Field Communications

NFC/HF RFID is a short-range wireless connectivity technology standard that enables a secure transaction between a reader and a contactless smart card.

The technology is based on ISO/IEC 14443 type A and B (proximity), ISO/IEC 15693 (vicinity), and FeliCa standards, using the HF 13.56 MHz unlicensed band.



NOTE: A Mobility DNA Enterprise License is required to pair and connect Zebra ring scanners.

The device supports the following operating modes:

- Reader mode
- Card Emulation mode.

Using NFC, the device can:

- Read contactless cards, such as contactless tickets, ID cards, and ePassport.
- Read and write information to contactless cards, such as SmartPosters and tickets, as well as devices with an NFC interface, such as vending machines.

- Read information from supported medical sensors.
- Pair with supported Bluetooth devices such as printers (for example, ZQ5x, ZD5x), ring scanners (for example, RS6000), and headsets (for example, HS3100).
- Exchange data with another NFC device.
- Emulate a contactless card such as a ticket.
- Emulate contactless cards such as a payment or ticket.

The device's NFC antenna is positioned to read NFC cards from the top of the device while the device is being held.

Reading NFC Cards

Read contactless cards using NFC.

1. Launch an NFC-enabled application.
2. Hold the device as shown.

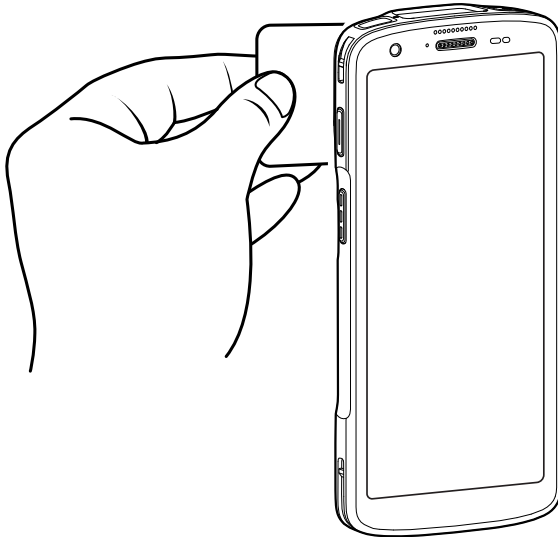

3. Move the device close to the NFC card until it detects the card.
4. Hold the card steadily until the transaction is complete (usually indicated by the application).

Enterprise NFC Settings

Improve NFC performance or increase battery life by selecting which NFC features to use on the device.

- **Card Detection Mode** - Select a card detection mode.
 - **Low** - Increases battery life by lowering the NFC detection speed.
 - **Hybrid** - Provides a balance between NFC detection speed and battery life (default).
 - **Standard** - Provides the optimal NFC detection speed, but reduces battery life.

- **Supported Card Technology** - Select an option to detect only one NFC tag type, increasing battery life, but reducing detection speed.
 - **All (Default)** - Detects all NFC tag types. This provides the best detection speed, but reduces battery life.
 - **ISO 14443 Type A**
 - **ISO 14443 Type B**
 - **ISO 15693**
- **NFC Debug Logging** - Use to enable or disable debug logging for NFC.
- **Other NFC settings available with Zebra administrator tools (CSP)** - Allows configuration of additional Enterprise NFC Settings through staging tools and Mobile Device Management (MDM) solutions with an MX version that supports the Enterprise NFC Settings Configuration Service Provider (CSP). For more information on using the Enterprise NFC Settings CSP, refer to: techdocs.zebra.com.

Calls

Make a phone call from the Phone app, the Contacts app, or other apps or widgets that display contact information.



NOTE: This section applies to WWAN devices only.

Emergency Calling

The service provider programs one or more emergency phone numbers, such as 911 or 999, that the user can call under any circumstances, even when the phone is locked, a SIM card is not inserted or the phone is not activated. The service provider can program additional emergency numbers into the SIM card. However, the SIM card must be inserted in the device in order to use the numbers stored on it. See the service provider for additional information.



NOTE: Emergency numbers vary by country. The phone's pre-programmed emergency number(s) may not work in all locations, and sometimes an emergency call cannot be placed due to network, environmental, or interference issues

Audio Modes

The device offers three audio modes for use during phone calls.

- Handset Mode - Switch audio to the receiver at the top front of the device to use the device as a handset. This is the default mode.
- Speaker Mode - Use the device as a speakerphone.
- Headset Mode - Connect a Bluetooth or wired headset to automatically switch audio to the headset.

Bluetooth Headset

Use a Bluetooth headset for audio communication when using an audio-enabled app.

Set the volume appropriately before putting on the headset. When a Bluetooth headset is connected, the speakerphone is muted.



Adjusting Audio Volume







Use the volume buttons to adjust the phone volume.

- Ring and notification volumes when not in a call.
- Conversation volume during a call.

Making a Call Using the Dialer



Use the dialer tab to dial phone numbers.

1. On the Home screen touch .
2. Touch .
3. Touch the keys to enter the phone number.
4. Touch  below the dialer to initiate the call.

Option	Description
	Send audio to the speakerphone.
	Mute the call.
	Display the dial pad.
	Place the call on hold (not available on all services).
	Create a conference call.
	Increase audio level.

5. Touch  to end the call.

If using a Bluetooth headset, additional audio options are available. Touch the audio icon to open the audio menu.

Option	Description
	Audio is routed to the Bluetooth headset.
	Audio is routed to the speakerphone.
	Audio is routed to the earpiece.

Accessing Dialing Options



The dialer provides options to save the dialed number to contacts, send an SMS, or insert pauses and wait into the dial string.







- Enter at least one digit in the dialer, then touch .
 - **Add 2-sec pause** - Pause the dialing of the next number for two seconds. Multiple pauses are added sequentially.
 - **Add wait** - Wait for confirmation to send the rest of the digits.

Make a Call Using Contacts

There are two ways to make a call using contacts, using the Dialer or using the Contacts app.



Using the Dialer

1. On the Home screen touch .
2. Touch .
3. Touch the contact.
4. Touch  to initiate the call.



Option	Description
	Send audio to the speakerphone.
	Mute the call.
	Display the dial pad.
	Place the call on hold (not available on all services).
	Create a conference call.
	Increase audio level.

5. Touch  to end the call.

If using a Bluetooth headset, additional audio options are available. Touch the audio icon to open the audio menu.

Option	Description
	Audio is routed to the Bluetooth headset.
	Audio is routed to the speakerphone.
	Audio is routed to the earpiece.

Using the Contacts App



1. Touch .
2. Touch a contact name.
3. Touch  to initiate the call.

Make a Call Using Call History





Call History is a list of all the calls placed, received, or missed. It provides a convenient way to redial a number, return a call, or add a number to Contacts.

Arrow icons beside a call indicate the type of call. Multiple arrows indicate multiple calls.

Table 26 Call Type Indicators

Icon	Description
	Missed incoming call
	Received incoming call
	Outgoing call

Using the Call History List





1. On the Home screen touch .
2. Touch the  tab.
3. Touch  next to the contact to initiate the call.
4. Touch the contact to perform other functions.
5. Touch  to end the call.



Making a Conference Call on GSM



Create a conference phone session with multiple people





NOTE: Conference Calling and the number of conference calls allowed may not be available on all services. Please check with the service provider for Conference Calling availability.



1. On the Home screen touch .
2. Touch .
3. Touch the keys to enter the phone number.
4. Touch  below the dialer to initiate the call.
5. When the call connects, touch .

The first call is placed on hold.
6. Touch .
7. Touch the keys to enter the second phone number.
8. Touch  below the dialer to initiate the call.

When the call connects, the first call is placed on hold and the second call is active.
9. Touch  to create a conference call with three people.
10. Touch  to add another call.

The conference is placed on hold.

11. Touch .
12. Touch the keys to enter another phone number.
13. Touch  below the dialer to initiate the call.
14. Touch  icon to add the third call to the conference.
15. Touch **Manage conference call** to view all callers.

Option	Description
	Remove a caller from the conference.
	Speak privately with one party during a conference call.
	Include all parties again.

Making a Call Using a Bluetooth Headset

1. Pair the Bluetooth headset with the device.
2. Press the Call button on the Bluetooth headset.
3. Press the Call button on the Bluetooth headset to end the call.

Answering Calls

When receiving a phone call, the **Incoming Call** screen displays the caller ID and any additional information about the caller that is in the **Contacts** app.





NOTE: Not all options are available for all configurations.

To modify phone call settings, on the Home screen touch  >  > **Settings**.

- Touch **ANSWER** to answer the call or **DECLINE** to send the caller to voice mail.

If the screen lock is enabled, the user can answer the call without unlocking the device.

- When a call arrives:

- Touch  and slide up to answer the call.
- Touch  and slide down to send the call to voice mail.
- Touch  to open a list of quick text responses. Touch one to send it to the caller immediately.

When the calls ends, the device remains locked.

If using a Bluetooth headset when a call arrives, touch the Call button on the Bluetooth headset to answer the call. To end the call press the headset Call button.

All incoming calls are recorded in the Phone app Call log tab. If you miss a call, you receive a notification. To silence the ringer before answering the call, press the volume down button on the side of device.

Call Settings

To modify phone call settings, on the Home screen touch  >  > **Settings**.



NOTE: Not all options are available for all configurations.

Assistive

- **Caller ID & spam**
 - **See caller and spam ID** - Enable to identify business and spam numbers.
 - **Filter spam calls** - Enable to prevent suspected spam calls from disturbing you.
 - **Verified calls** - Enable to see the caller ID and reason for incoming calls from businesses.

Assistive

- **Caller ID & spam**
 - **See caller and spam ID** - Enable to identify business and spam numbers.
 - **Filter spam calls** - Enable to prevent suspected spam calls from disturbing you.
 - **Verified calls** - Enable to see the caller ID and reason for incoming calls from businesses.

General

- **Accessibility**
 - **TTY mode** - Touch to set the TTY setting. Use an optional teletypewriter (TTY) with the device to send and receive calls. Plug the TTY into the device headset jack and set the device to operate in one of the TTY modes.



NOTE: Use a TSB-121 compliant cable (provided by the TTY manufacturer) to connect the TTY to the device.

Set the device volume to a middle level setting for proper operation. If you experience a high number of incorrect characters, adjust the volume as needed to minimize the error rate.

For optimal performance, the device should be at least 30 cm (12 inches) from the TTY. Placing the device too close to the TTY may cause high error rates.

- **TTY off** - TTY is off (default)
- **TTY Full** - Transmit and receive TTY characters
- **TTY HCO** - Transmit TTY characters, but receive by listening to earpiece
- **TTY VCO** - Receive TTY characters, but transmit by speaking into microphone.
- **Hearing aids** - Select to enable hearing air compatibility.
- **RTT settings** - Configure Real-time text (RTT) settings.
 - **Real-time text (RTT) call** - Select to allow messaging during a call.
 - **Set RTT visibility** - Set to Visible during calls (default) or Always visible.
- **Assisted dialing** - Enable to predict and add a country code when calling while traveling abroad.
- **Default home country** - Automatically detected.

- **Blocked numbers** - Set to block calls and texts from certain phone numbers. Touch **ADD A NUMBER** to block a phone number.
- **Blocked numbers** - Set to block calls and texts from certain phone numbers.
 - **Unknown** - Block calls from unidentified callers.
 - **Add a number** - Block a specific phone number.
- **Calling accounts**
 - **Settings** - Touch a mobile provider to display options for that provider.
 - **Smart-Divert** - Set to enable call diversion (forwarding) with remote control which allows controlling the diversion functionality remotely.



NOTE: Smart-Divert may not be available on all networks. Check with the service provider for availability.

- **Make & receive calls** - Enable **Vibrating for outgoing call accepted** to enable vibrating mode when an outgoing call is accepted.
- **SIP settings** - Touch a mobile provider to display options for that provider.
 - **SIP accounts** - Choose to receive Internet calls for accounts added to the device, view or change SIP accounts, or add an Internet calling account.
 - **Use SIP calling** - Set to **For all calls** or **Only for SIP calls** (default).
 - **Receive incoming calls** - Enable to allow incoming calls (default - disabled).
- **Display options**
 - **Sort by** - Set to **First name** or **Last name**.
 - **Name format** - Set to **First name first** or **Last name first**.
 - **Choose theme** - Set to **Light**, **Dark**, or **System default**.
- **Nearby places** - Enable to use your location to find nearby places matching a query, even if not in contacts.
 - **Personalized search results** - Enable to improve search results by including items in search history.
 - **Location permission is denied** - Enable to require location permission to conduct a nearby places search.
- **Quick responses** - Touch to edit quick responses to use instead of answering a call.
- **Sounds and vibration** - Touch to edit the general sound settings for the device.
- **Speed dial settings** - Set speed dial contact shortcuts.

- **Voicemail** - Configure voicemail settings.
 - **Notifications** - Configure voicemail notification settings.
 - **Show notifications** - Touch to receive sound and vibration notifications when a voicemail is received. Use toggle switches to enable or disable Pop on screen, Vibration, Blink light, Show notification dot, and Override Do Not Disturb.
 - **Default** - Touch to receive sound and vibration notifications when a voicemail is received based on phone settings.
 - **Silent** - Touch to silence sound and vibration notifications when a voicemail is received.
 - **Pop on screen** - Enable to show notifications as a banner across the top of the screen when the device is unlocked.
 - **Advanced** - Touch to display the following items.
 - **Sound** - Select a sound to play for notifications from this app.
 - **Vibration** - Allow notifications from this app to vibrate the device.
 - **Blink light** - Allow notifications from this app the light the Notification LED blue.
 - **Show notification dot** - Allow notifications from this app to add a notification dot to the app icon.
 - **Override Do Not Disturb** - Allow these notifications to interrupt when Do Not Disturb is enabled.
 - **Advanced Settings**
 - **Service** - Set the service provider or other provider for voicemail service.
 - **Setup** - Select to update the phone number used to access voicemail.

Advanced

- **Caller ID announcement** - Set to **Always**, **Only when using a headset**, or **Never** to read the caller's name and number out loud for incoming calls.
- **Flip To Silence** - Enable to silence an incoming call by placing the phone face down on a flat surface.

Accessories

This section provides information for using the accessories for the device.

The following table lists the accessories available for the device.

Accessory	Part Number	Description
Cradles		
1-Slot Charge Only Cradle	CRD-TC2L-BS1CO-01	Provides device charging only. Requires USB-C cable (CBL-TC5X-USBC2A-01) and power supply (PWR-WUA5V12W0xx).
1-Slot USB Cradle	CRD-TC2L-SE1ET-01	Provides device charging and communication. Requires power supply (PWR-BGA12V50W0WW), DC line cord (CBL-DC-388A1-01), and country-specific AC line cord.
1-Slot Charge Only with Spare Battery Cradle	CRD-TC2L-BS11B-01	Provides device charging and charging for a spare battery. Requires power supply (PWR-BGA12V50W0WW), DC line cord (CBL-DC-388A1-01), and country-specific AC line cord.
5-Slot Charge Only Cradle	CRD-TC2L-BS5CO-01	Charges up to five devices. Charges up to four devices and four spare batteries. Requires power supply (PWR-BGA12V108W0WW), DC line cord (CBL-DC-381A1-01), and country-specific AC line cord.
5-Slot Ethernet Cradle	CRD-TC2L-SE5ET-01	Provides device charging and provides Ethernet communication for up to five devices. Requires power supply (PWR-BGA12V108W0WW), DC line cord (CBL-DC-381A1-01), and country-specific AC line cord.
Cradle Mount	BRKT-SCRD-SMRK-01	Mounts the 5-Slot Charge Only Cradle, 5-Slot Ethernet Cradle, and 4-Slot Battery Charger to a wall or rack.
USB-Ethernet Adapter	MOD-MT2-EU1-01	Provides USB and Ethernet communication with the 1-Slot USB Cradle. Requires bracket BRKT-TC51-ENET1-02.
Batteries and Chargers		

Accessories

Accessory	Part Number	Description
Standard 3,800 mAh PowerPrecision LI-ON Battery	BTRY-TC2L-2XMAXX-01	Replacement standard battery (single pack).
Standard 3,800 mAh PowerPrecision LI-ON Battery with BLE Beacon	BTRYTC2L- 2XMAXB-01	Replacement standard battery with BLE beacon (single pack).
Extended 5,200 mAh PowerPrecision LI-ON Battery	BTRY-TC2L-3XMAXX-01	Replacement extended battery (single pack).
4-Slot Battery Charger	SAC-TC2L-4SCHG-01	Charges up to four battery packs. Requires power supply (PWR-BGA12V50W0WW), DC line cord (CBL-DC-388A1-01), and country-specific AC line cord.
Charge and Communication Cables		
USB-C Communication and Charge Cable	CBL-TC5X-USBC2A-01	Provides UBC-A to USB-C communication and power to the device.
Micro USB Communication Cable	25-124330-01R	Provides USB communication for the 1-Slot USB Cradle.
Audio Accessories		
USB-C Digital Audio Adapter	ADP-USBC-35MM1-01	Plugs into the device and provides audio to a wired headset with a collared 3.5 mm plug.
HS2100 Rugged Wired Headset	HS2100-OTH	Rugged Corded Headset. Includes HS2100 Boom Module and HSX100 OTH Headband Module.
HS2100 3.5 mm Headset Cable	CBL-HS2100-3MS1-01	Plugs into the HS2100 headset and provides a collared 3.5 mm plug. Requires USB-C Digital Audio Adapter (ADP-USBC-35MM1-01).
HS3100 Rugged Wired Headset	HS3100-OTH	Rugged Wireless Headset. Includes HS3100 Boom Module and HSX100 OTH Headband Module.
Wired Headset	HDST-USBC-PTT1-01	PTT headset with USB-C connector.
Wired headset	HDST-35MM-PTVP-02	PTT and VoIP headset with 3.5 mm standard jack. Requires adapter ADP-USBC-35MM1-01.
Miscellaneous		
Trigger Handle	TRG-TC2L-SNP1-01	Adds a gun-style handle with a scanner trigger for comfortable and productive scanning.
Trigger Handle Wrist Strap	50-12500-066	Attaches to the bottom of the trigger handle.
Rugged Boot	SG-TC2L-BOOT-01	Provides increased drop protection.
Tempered Glass Screen Protector	SG-TC2L-SCRNPT1-01	Add additional screen protection.
Soft Holster	SG-TC2Y-HLSTR1-01	Use to hold the device on the hip. Accepts device with Trigger Handle

Accessories

Accessory	Part Number	Description
Hand Strap	SG-TC2Y-HSTRP1-01	Replacement hand strap with hand strap mounting clip (single pack).
Arm Mount	SG-TC2L-ARMNT-01	Arm mount for hands-free functionality. Includes Medium sized (300 mm) velcro straps (SG-ARMSTRAP-01, and comfort pad (SG-TC2L-CMPD-01).
Wrist Mount	SG-TC2L-WMADP1-02	Wrist mount for hands-free functionality. Includes swivel design to allow the device to be viewed in portrait or landscape mode.
Power Supplies		
Power Supply	PWR-BGA12V50W0WW	Provides power to the 1-Slot Charge Only Cradle, 1-slot USB Cradle, and 4-Slot Battery Charger. Requires DC line cord (p/n CBL-DC-3888A1-01 and country-specific three-wire grounded AC line cord sold separately.
Power Supply	PWR-BGA12V108W0WW	Provides power to the 5-Slot Charge Only cradle and the 5-Slot Ethernet Cradle. Requires DC Line Cord, p/n CBL-DC-381A1-01, and country-specific three-wire grounded AC line cord sold separately.
Power Supply	PWR-WUA5V12W0US	Provides 5 VDC, 2.5 A power to the USB cable. Includes plug adapter for use in the United States.
Power Supply	PWR-WUA5V12W0EU	Provides 5 VDC, 2.5 A power to the USB cable. Includes plug adapter for use in the European Union.
Power Supply	PWR-WUA5V12W0GB	Provides 5 VDC, 2.5 A power to the USB cable. Includes plug adapter for use in the United Kingdom.
Power Supply	PWR-WUA5V12W0AU	Provides 5 VDC, 2.5 A power to the USB cable. Includes plug adapter for use in Australia.
Power Supply	PWR-WUA5V12W0CN	Provides 5 VDC, 2.5 A power to the USB cable. Includes plug adapter for use in China.
Power Supply	PWR-WUA5V12W0IN	Provides 5 VDC, 2.5 A power to the USB cable. Includes plug adapter for use in India.
Power Supply	PWR-WUA5V12W0KR	Provides 5 VDC, 2.5 A power to the USB cable. Includes plug adapter for use in Korea.
Power Supply	PWR-WUA5V12W0BR	Provides 5 VDC, 2.5 A power to the USB cable. Includes plug adapter for use in Brazil.
DC Line Cord	CBL-DC-381A1-01	Provides power from the power supply (PWR-BGA12V108W0WW) to the 5-Slot Charge Only Cradle and 5-Slot Ethernet Cradle.

Accessory	Part Number	Description
DC Line Cord	CBL-DC-388A1-01	Provides power from the power supply (PWR-BGA12V50W0WW) to the 1-Slot Charge Only Cradle, 1-Slot USB with Spare Battery Cradle, and 4-Slot Battery Charger.
2-way DC Cable	CBL-DC-523A1-01	Connects one power supply (PWR-BGA12V108W0WW) to two 4-Slot Battery Chargers.
US AC Line Cord	23844-00-00R	Provide power to power supplies.

Main Battery Charging

Before using the device for the first time, charge the main battery until the green Charging/Notification light-emitting diode (LED) remains lit. Use a cable or a cradle with the appropriate power supply to charge the device.

There are three batteries available:

- Standard 3,800 mAh PowerPrecision LI-ON Battery - part number: BTRY-TC2L-2XMAXX-01
- Standard 3,800 mAh PowerPrecision LI-ON Battery with BLE Beacon - part number: BTRY-TC2L-2XMAXB-01
- Extended 5,200 mAh PowerPrecision LI-ON Battery - part number BTRY-TC2L-3XMAXX-01

The device's Charging/Notification LED indicates the battery charging status in the device. The standard battery charges from fully depleted to 80% in less than 1 hour and 20 minutes. The extended battery charges from fully depleted to 80% in less than 1 hour and 50 minutes.



NOTE: Charge batteries at room temperature with the device in Sleep mode.

Table 27 Charging/Notification LED Charging Indicators

State	Indication
Off	The device is not charging. It is incorrectly inserted in the cradle or connected to a power source, and the charger/cradle is not powered.
Slow Blinking Amber (1 blink every 4 seconds)	The device is charging.
Slow Blinking Red (1 blink every 4 seconds)	The device is charging, but the battery is at the end of its useful life.
Solid Green	Charging complete.
Solid Red	Charging is complete, but the battery is at the end of its useful life.
Fast Blinking Amber (2 blinks/second)	Charging error, for example: <ul style="list-style-type: none"> • Temperature is too low or too high. • Charging has gone on too long without completion (typically eight hours).

Table 27 Charging/Notification LED Charging Indicators (Continued)

State	Indication
Fast Blinking Red (2 blinks/second)	Charging error but the battery is at the end of its useful life, for example: <ul style="list-style-type: none"> • Temperature is too low or too high. • Charging has gone on too long without completion (typically eight hours).

Spare Battery Charging

The Spare Battery Charging LEDs on the 4-Slot Battery Charger indicate the status of the spare battery charging.

The standard and extended battery charges from fully depleted to 90% in less than 4 hours.

LED	Indication
Solid Amber	The spare battery is charging.
Solid Green	The spare battery charging is complete.
Solid Red	The spare battery is charging, and the battery is at the end of its useful life. Charging is complete, and the battery is at the end of its useful life.
Fast Blinking Red (2 blinks/second)	Error in charging; check the placement of the spare battery, and the battery is at the end of its useful life.
Off	No spare battery in the slot. The spare battery is not placed in the slot correctly. The cradle is not powered.

Charging Temperature

Charge batteries in temperatures from 5°C to 40°C (41°F to 104°F). The device or cradle always performs battery charging safely and intelligently. At higher temperatures (for example, approximately +37°C / +98°F), the device or cradle may, for small periods, alternately enable and disable battery charging to keep the battery at acceptable temperatures. The device and cradle indicate when charging is disabled due to abnormal temperatures via its LED.

1-Slot Charge Only Cradle

This cradle provides power to the device.



CAUTION: Ensure that you follow the guidelines for battery safety described in [Battery Safety Guidelines](#) on page 191.

The 1-Slot Charge Only Cradle:

- Provides 5 VDC power for operating the device.
- Charges the device's battery.

Figure 27 1-Slot Charge Only Cradle

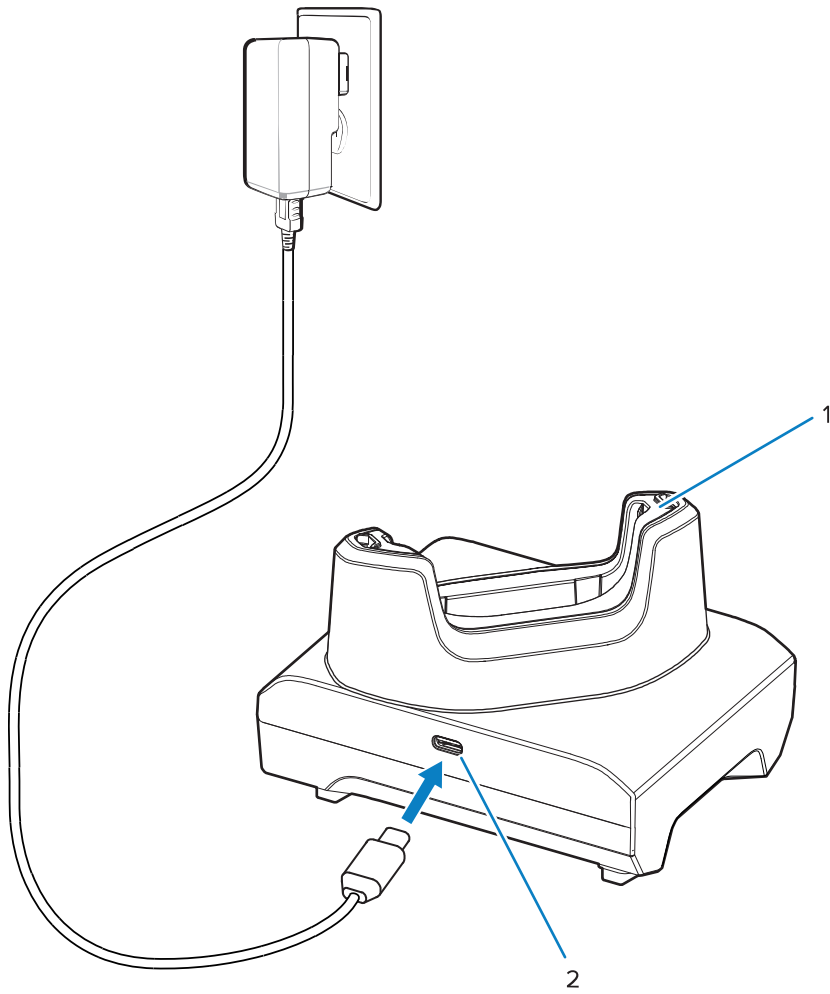

1	Device charging slot with shim.
2	USB power port.

Setup

The 1-Slot Charge Only Cradle provides device charging.

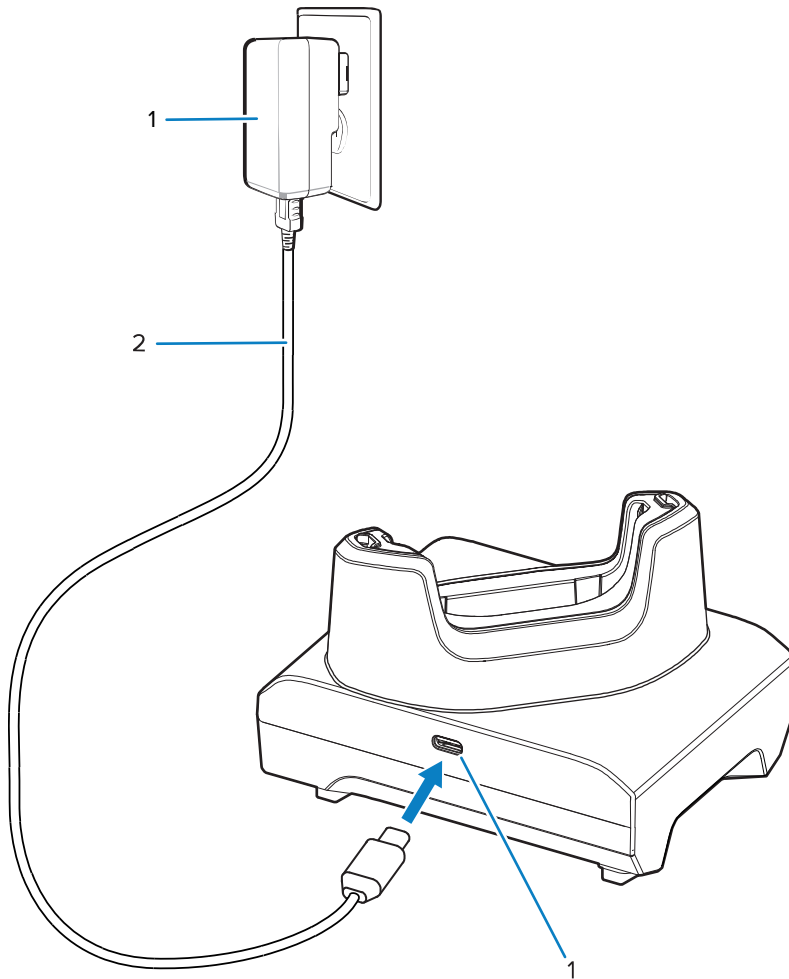

1	USB-C port
2	USB-C cable
3	Power supply

Charging the Device

Place the device in the slot to charge the device.

1. Insert the device into a slot to begin charging.



2. Ensure the device is seated properly.

1-Slot USB Cradle

This cradle provides power and USB communications.



CAUTION: Ensure that you follow the guidelines for battery safety described in [Battery Safety Guidelines](#) on page 191.

The 1-Slot USB Cradle:

- Provides 5 VDC power for operating the device.
- Charges the device's battery.
- Provides USB communication with a host computer.
- With an optional Ethernet Module and bracket provides USB with a host computer and/or Ethernet communications with a network.

Figure 28 1-Slot USB Cradle

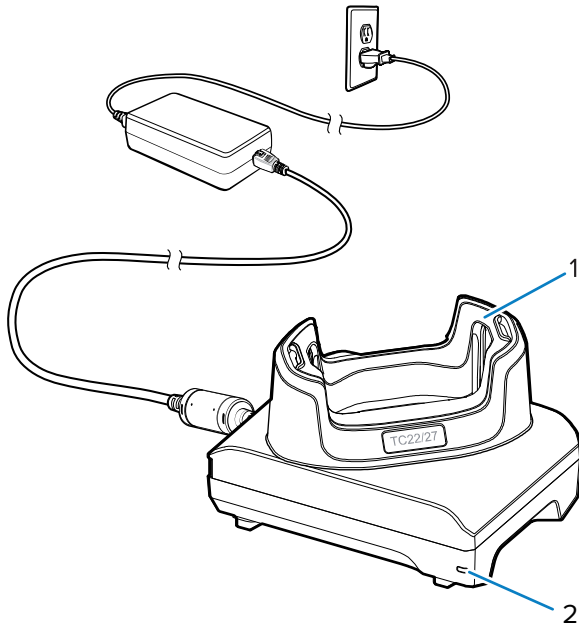

1	Device charging slot with shim.
2	Power LED

Setup

The 1-Slot USB Cradle provides device charging.

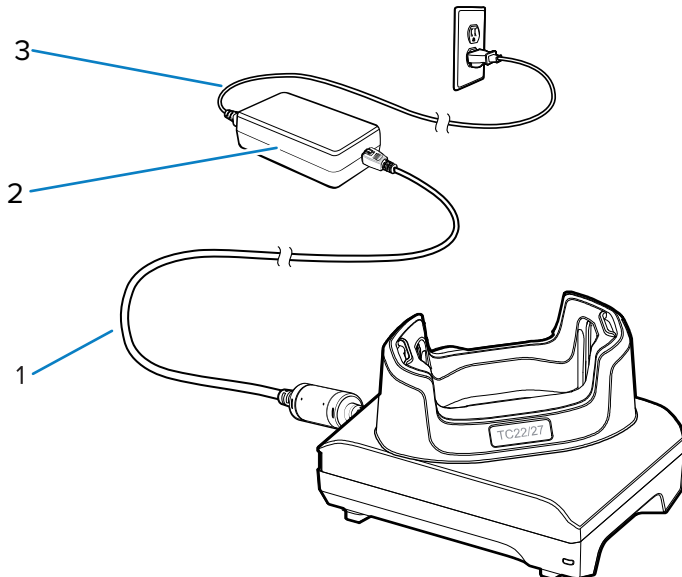

1	DC line cord
2	Power supply
3	AC line cord

Charging the Device

Place the device in the slot to charge the device.

1. Insert the device into a slot to begin charging.



2. Ensure the device is seated properly.

Ethernet Communication

This section describes how to establish an Ethernet connection, configure proxy settings, and configure a static IP address.

Ethernet LED Indicators

There are two green LEDs on the side of the cradle. These green LEDs light and blink to indicate the data transfer rate.

Table 28 LED Data Rate Indicators

Data Rate	1000 LED	100/10 LED
1 Gbps	On/Blink	Off
100 Mbps	Off	On/Blink
10 Mbps	Off	On/Blink

Establishing Ethernet Connection

1. Go to **Settings**.
2. Touch **Network & internet > Ethernet**.
3. Slide the Ethernet switch to the **ON** position.
4. Insert the device into a slot.

The  icon appears in the Status bar.

5. Touch **Eth0** to view Ethernet connection details.

Configuring Ethernet Proxy Settings

The device includes Ethernet cradle drivers. After inserting the device, configure the Ethernet connection.

1. Go to **Settings**.
2. Touch **Network & internet > Ethernet**.
3. Slide the switch to the **ON** position.
4. Place the device into the Ethernet cradle slot.
5. Touch and hold **eth0** until the menu appears.
6. Touch **Modify Proxy**.
7. Touch the **Proxy** drop-down list and select **Manual**.
8. In the **Proxy hostname** field, enter the proxy server address.
9. In the **Proxy port** field, enter the proxy server port number.



NOTE: When entering proxy addresses in the Bypass proxy for field, do not use spaces or carriage returns between addresses.

10. In the **Bypass proxy for** text box, enter addresses for web sites that do not require to go through the proxy server. Use the separator “|” between addresses.
11. Touch **MODIFY**.
12. Touch Home.

Configuring Ethernet Static IP Address

The device includes Ethernet cradle drivers. After inserting the device, configure the Ethernet connection.

1. Go to **Settings**.
2. Touch **Network & internet > Ethernet**.
3. Slide the switch to the **ON** position.
4. Place the device into the Ethernet cradle slot.
5. Touch **eth0**.
6. Touch **Disconnect**.
7. Touch **eth0**.
8. Touch the IP settings drop-down list and select **Static**.
9. In the **IP** address field, enter the proxy server address.
10. If required, in the **Gateway** field, enter a gateway address for the device.
11. If required, in the **Netmask** field, enter the network mask address
12. If required, in the **DNS** address fields, enter a Domain Name System (DNS) addresses.
13. Touch **CONNECT**.
14. Touch Home.

1-Slot Charge Only with Spare Battery Cradle

This cradle provides power for charging a device and a spare battery.



CAUTION: Ensure that you follow the guidelines for battery safety described in [Battery Safety Guidelines](#) on page 191.

The 1-Slot Charge Only with Spare Battery Cradle:

- Provides 5 VDC power for operating the device.
- Charges the device's battery.
- Charges a spare battery.

Figure 29 1-Slot Cradle with Spare Battery Slot

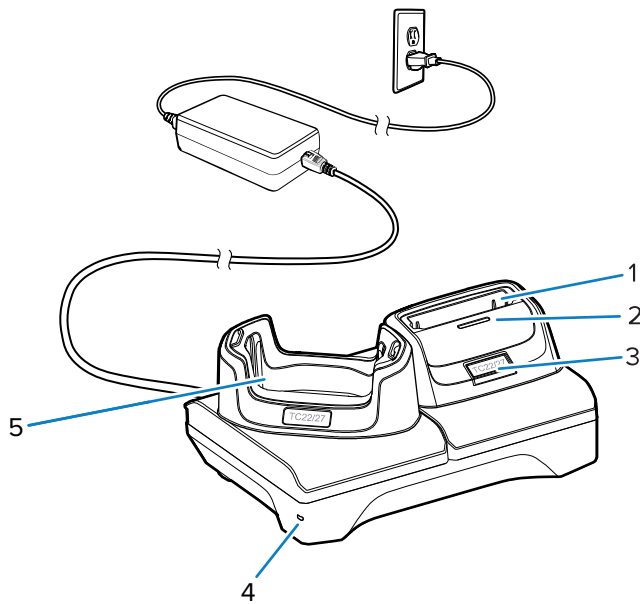

1	Spare battery charging slot.
2	Spare battery charging LED
3	USB-C port The USB-C port is a service connector only for firmware upgrades and is not intended for power charging.
4	Power LED
5	Device charging slot with shim

Setup

The 1-Slot Cradle with Spare Battery Slot provides a device and a spare battery charging.

Figure 30 1-Slot Cradle with Spare Battery Slot Setup

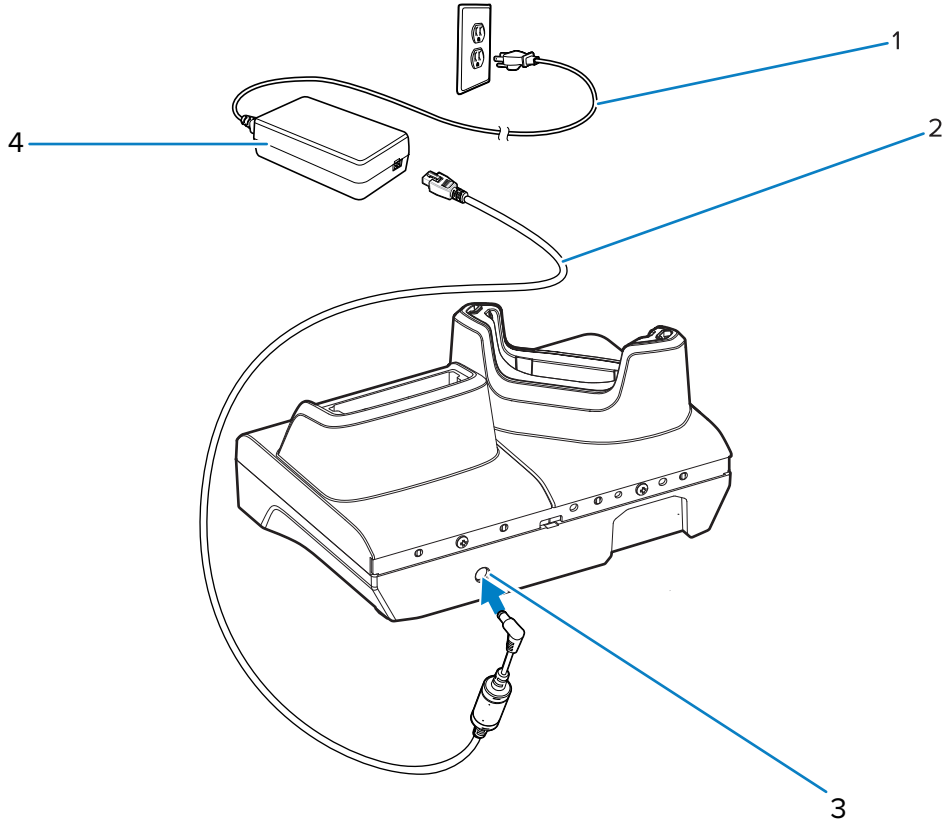

1	AC line cord
2	DC line cord
3	Power port
4	Power supply

Charging the Device

Place the device in the slot to charge the device.

1. Insert the device into a slot to begin charging.



2. Ensure the device is seated properly.

4-Slot Battery Charger

This section describes how to use the 4-Slot Battery Charger to charge up to four device batteries.



CAUTION: Ensure that you follow the guidelines for battery safety described in [Battery Safety Guidelines](#) on page 191.

Figure 31 4-Slot Battery Charger

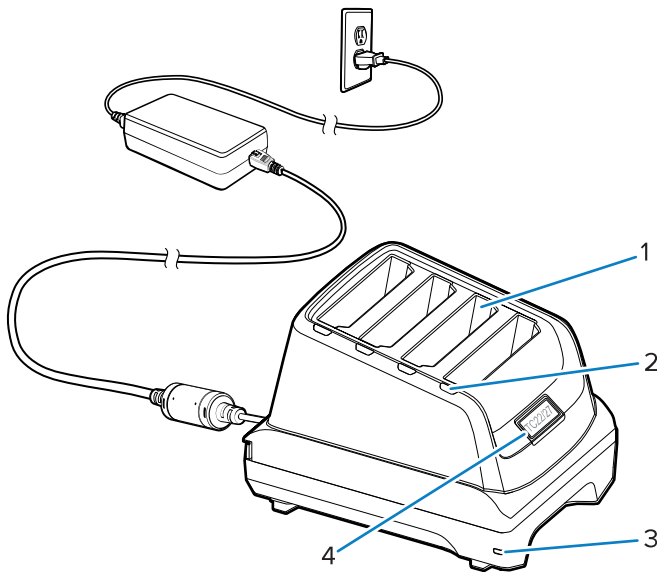

1	Battery Slot
2	Battery Charging LED

3	Power LED
4	USB-C port The USB-C port is a service connector for firmware upgrade only and not intended for power charging.

Setup

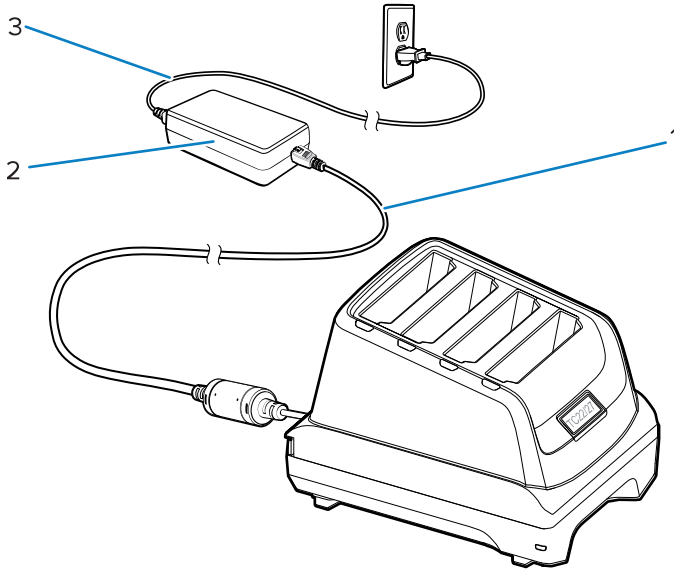

1	DC line cord
2	Power supply
3	AC line cord

Two Charger Setup

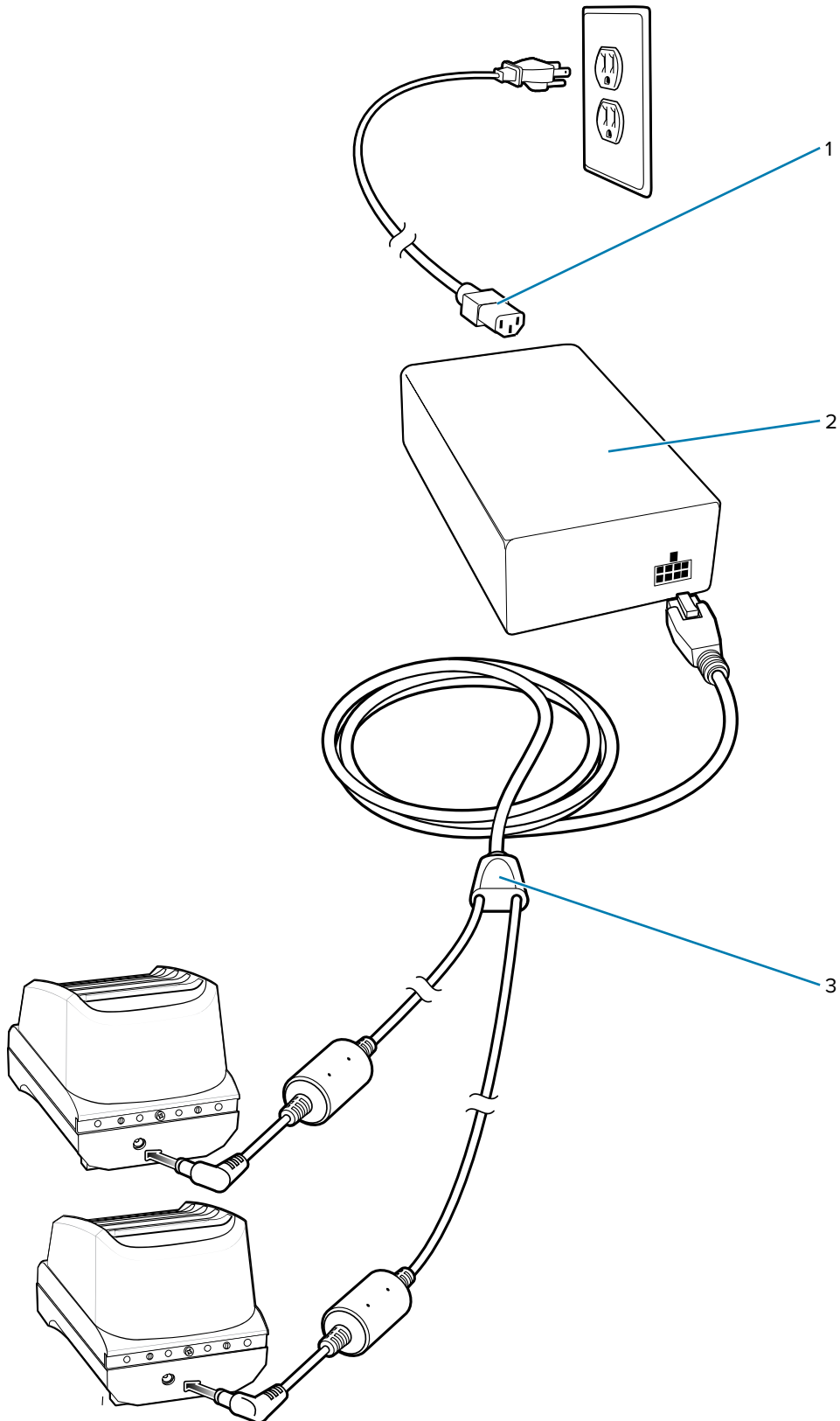

1	AC line cord
2	Power supply
3	DC Y-cord

1. Plug the 2-way DC Cable plugs into the power port on the back of each charger.
2. Plug the 2-way DC Cable connector into the power output of the power supply (PWR-BGA12V108W0WW).
3. Plug the AC line cord into the power supply.
4. Plug the AC line cord into an AC outlet.

Charging Spare Batteries

Insert a battery into one of the four charging slots.

1. Connect the charger to a power source.
2. Insert the battery into a battery charging slot and gently press down on the battery to ensure proper contact.

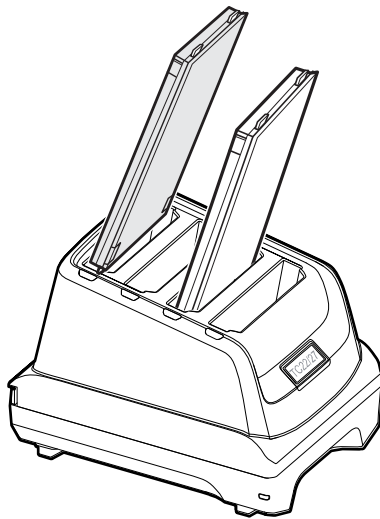

Each Battery Charging LED indicates the status of the battery charging in each slot. See [Spare Battery Charging](#) on page 135 for spare battery charging indicator descriptions.

5-Slot Charge Only Cradle

This section describes how to use the 5-Slot Battery Charger to charge up to five device batteries.



CAUTION: Ensure that you follow the guidelines for battery safety described in [Battery Safety Guidelines](#) on page 191.

The 5-Slot Charge Only Cradle:

- Provides 5 VDC power for operating the device.

- Simultaneously charges up to five devices.

Figure 32 5-Slot Charge Only Cradle

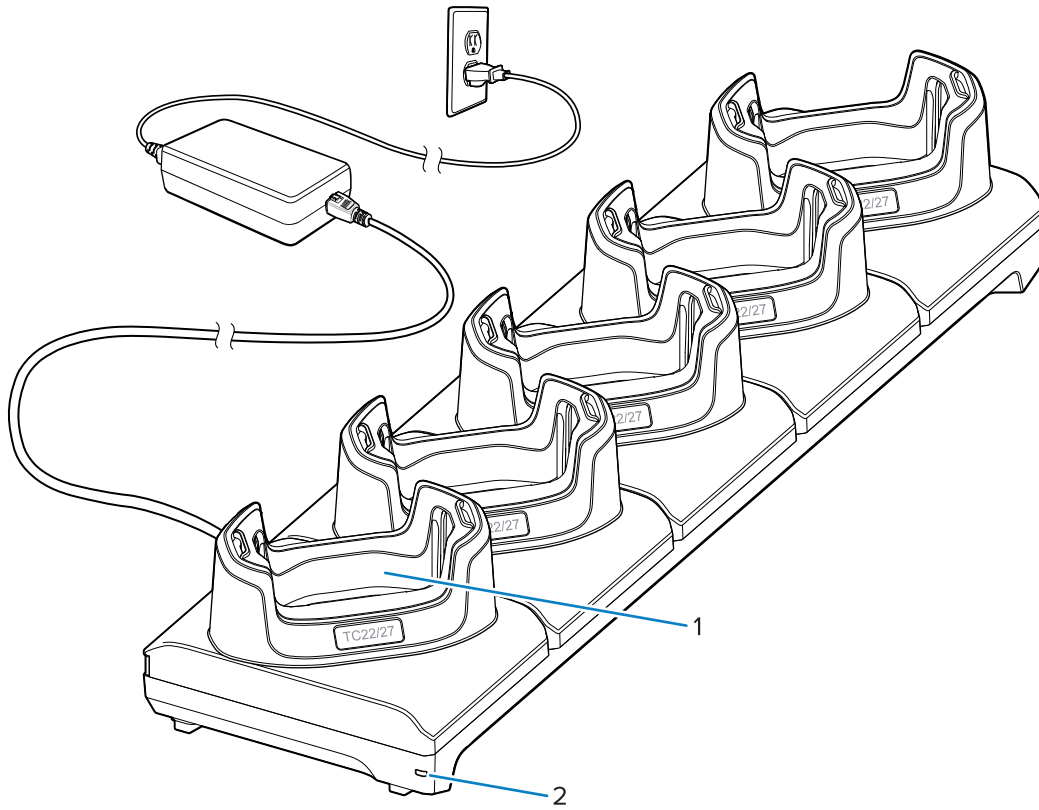

1	Device charging slot with shim
2	Power LED

Setup

The 5-Slot Charge Only cradle charges up to five devices.

Figure 33 5-Slot Charge Only Cradle Setup

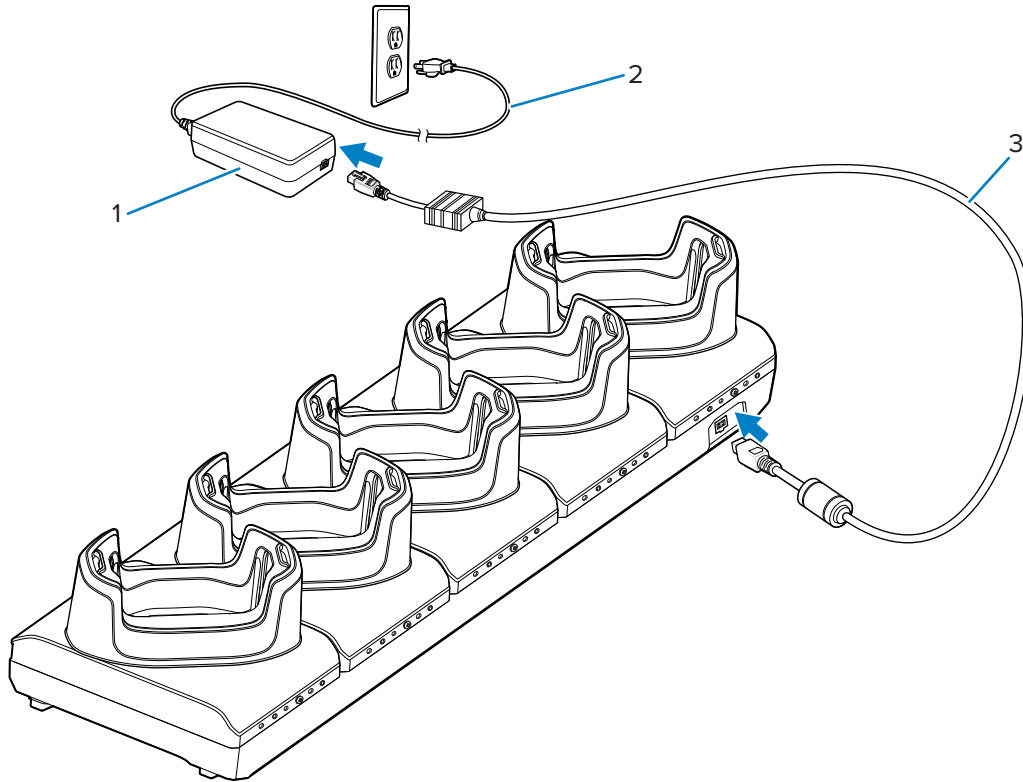

1	Power supply
2	AC line cord
3	DC line cord

Charging the Device

Place the device in the slot to charge the device.

1. Insert the device into a slot to begin charging.



2. Ensure the device is seated properly.

5-Slot Ethernet Cradle



CAUTION: Ensure that you follow the guidelines for battery safety described in [Battery Safety Guidelines](#) on page 191.

The 5-Slot Ethernet Cradle:

- Provides 5 VDC power for operating the device.
- Connects the device (up to five) to an Ethernet network.
- Simultaneously charges up to five devices.

Figure 34 5-Slot Ethernet Cradle

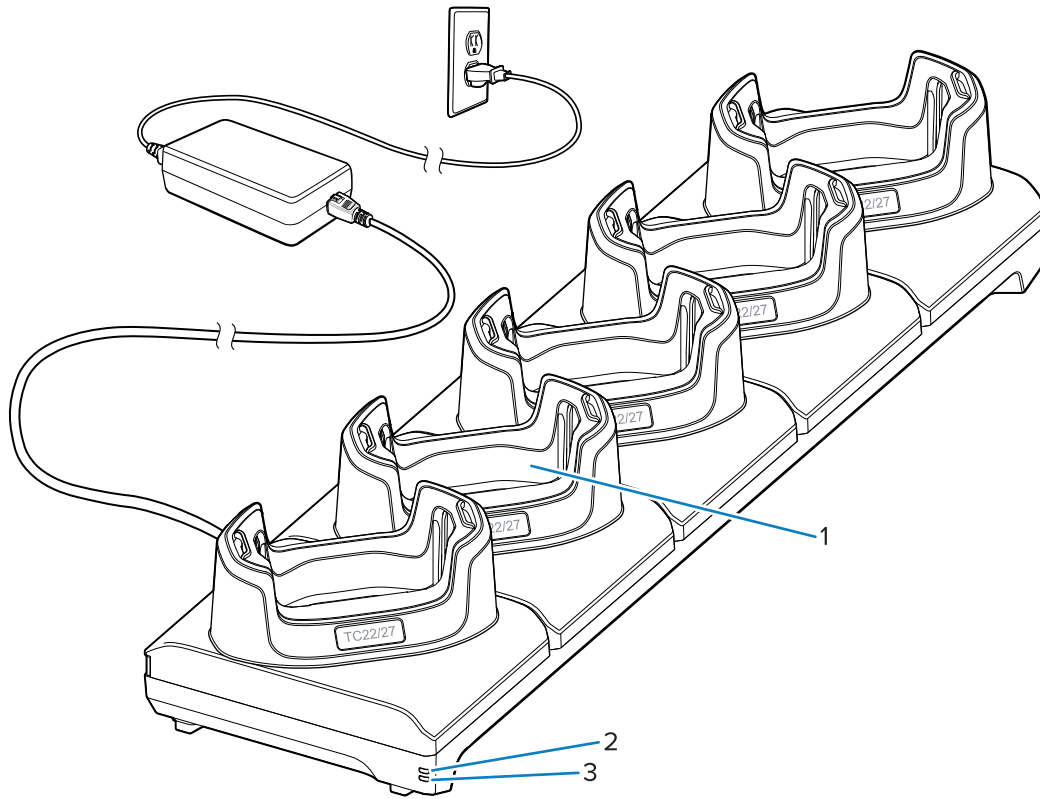

1	Device charging slot with shim
2	1000 LED
3	100/100 LED

Setup

The 5-Slot Ethernet cradle provides power and Ethernet communication for up to five devices.

Figure 35 5-Slot Ethernet Cradle Setup

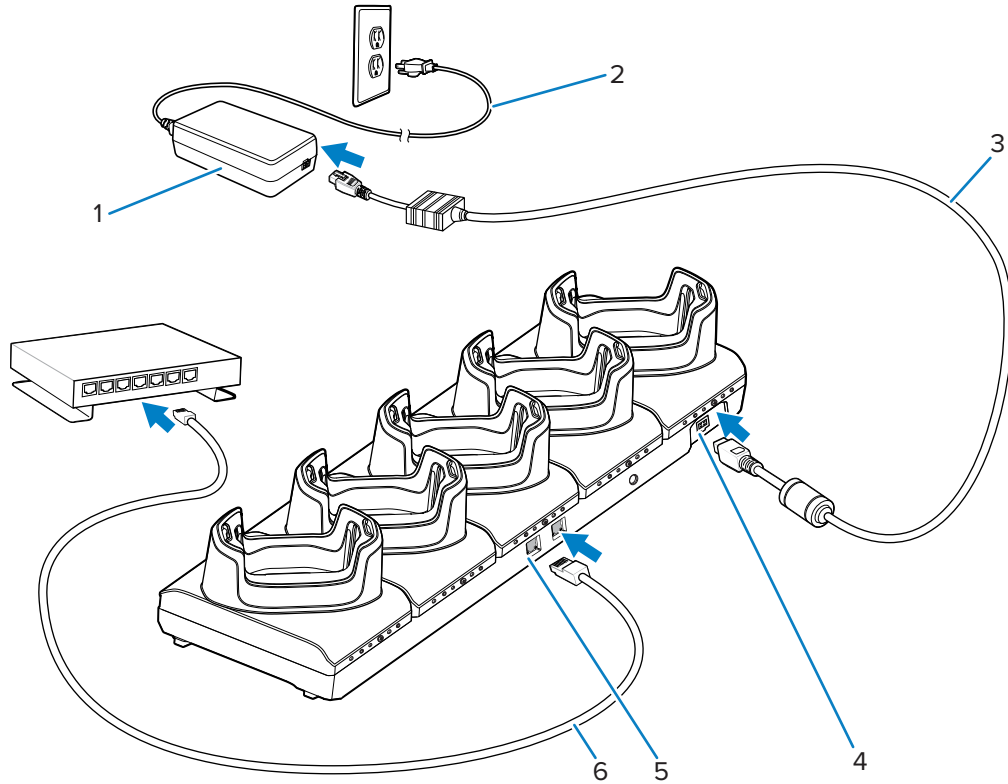

1	Power supply
2	AC line cord
3	DC line cord
4	Power port
5	Ethernet port
6	Ethernet cable

Daisy-chaining Ethernet Cradles

Daisy-chain up to ten 5-Slot Ethernet cradles to connect several cradles to an Ethernet network. Use either a straight or crossover cable. Daisy-chaining should not be attempted when the main Ethernet connection to the first cradle is 10 Mbps as throughput issues will almost certainly result.

1. Connect power to each 5-Slot Ethernet cradle.
2. Connect an Ethernet cable to one of the ports on the switch and the other end to the to Primary Port of the first cradle.
3. Connect an Ethernet cable to the Secondary port of the first cradle.

- Connect the other end of the Ethernet cable to the Primary port of the next 5-Slot Ethernet cradle.

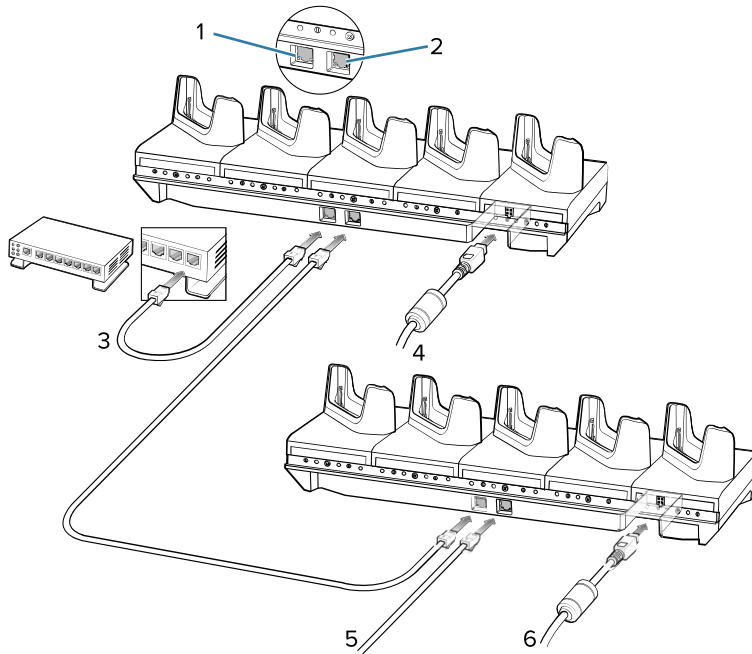

1	Primary Port
2	Secondary Port
3	To Switch
4	To Power Supply
5	To Next Cradle
6	To Power Supply

- Connect additional cradles as described in step 3 and 4.

Ethernet Communication

This section describes how to establish an Ethernet connection, configure proxy settings, and configure a static IP address.

Ethernet LED Indicators

There are two green LEDs on the side of the cradle. These green LEDs light and blink to indicate the data transfer rate.

Table 29 LED Data Rate Indicators

Data Rate	1000 LED	100/10 LED
1 Gbps	On/Blink	Off
100 Mbps	Off	On/Blink
10 Mbps	Off	On/Blink

Establishing Ethernet Connection

1. Go to **Settings**.
2. Touch **Network & internet > Ethernet**.
3. Slide the Ethernet switch to the **ON** position.
4. Insert the device into a slot.

The  icon appears in the Status bar.

5. Touch **Eth0** to view Ethernet connection details.

Configuring Ethernet Proxy Settings

The device includes Ethernet cradle drivers. After inserting the device, configure the Ethernet connection.

1. Go to **Settings**.
2. Touch **Network & internet > Ethernet**.
3. Slide the switch to the **ON** position.
4. Place the device into the Ethernet cradle slot.
5. Touch and hold **eth0** until the menu appears.
6. Touch **Modify Proxy**.
7. Touch the **Proxy** drop-down list and select **Manual**.
8. In the **Proxy hostname** field, enter the proxy server address.
9. In the **Proxy port** field, enter the proxy server port number.



NOTE: When entering proxy addresses in the Bypass proxy for field, do not use spaces or carriage returns between addresses.

10. In the **Bypass proxy for** text box, enter addresses for web sites that do not require to go through the proxy server. Use the separator “|” between addresses.
11. Touch **MODIFY**.
12. Touch Home.

Configuring Ethernet Static IP Address

The device includes Ethernet cradle drivers. After inserting the device, configure the Ethernet connection.

1. Go to **Settings**.
2. Touch **Network & internet > Ethernet**.
3. Slide the switch to the **ON** position.
4. Place the device into the Ethernet cradle slot.
5. Touch **eth0**.
6. Touch **Disconnect**.
7. Touch **eth0**.
8. Touch the IP settings drop-down list and select **Static**.

9. In the **IP** address field, enter the proxy server address.
10. If required, in the **Gateway** field, enter a gateway address for the device.
11. If required, in the **Netmask** field, enter the network mask address
12. If required, in the **DNS** address fields, enter a Domain Name System (DNS) addresses.
13. Touch **CONNECT**.
14. Touch Home.

Charging the Device

Place the device in the slot to charge the device.

1. Insert the device into a slot to begin charging.



2. Ensure the device is seated properly.

USB Cable

The USB cable plugs into the bottom of the device. When attached to the device, the cable allows charging, transferring data to a host computer, and connecting USB peripherals.

Figure 36 USB cable

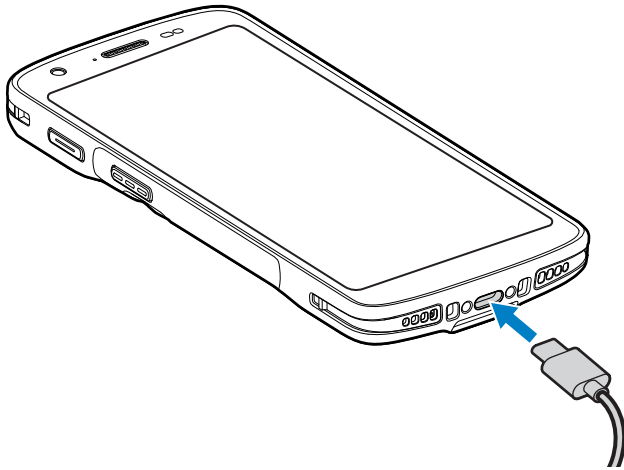

USB Communication

1. Connect the USB cable to the device.
2. Connect the USB connector of the cable to a host computer.

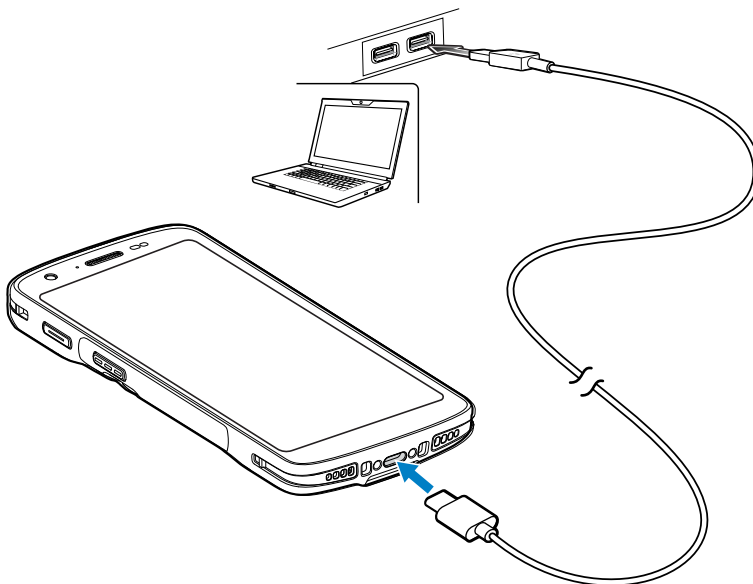

Charging the Device

1. Connect the USB cable to the device.
2. Connect the USB connector of the power supply.

3. Plug to power supply into a power outlet.



NOTE: See [USB Power Supply](#) for information on setting up the power supply.

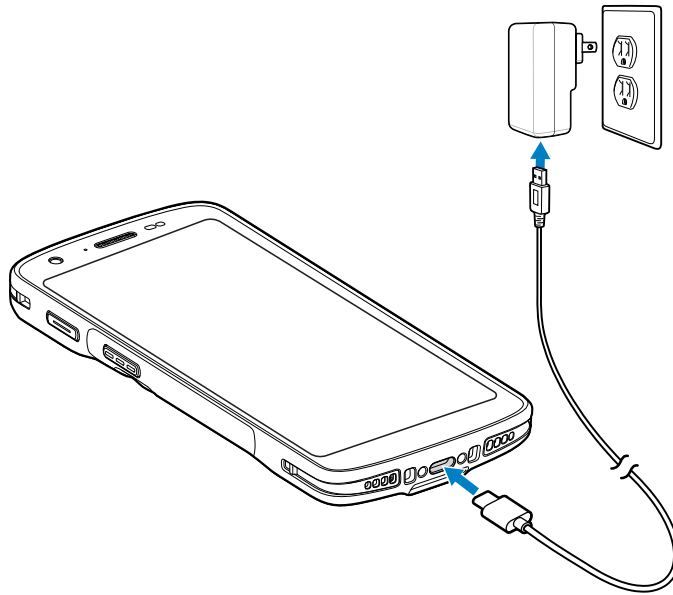

Handstrap

The hand strap provides security when holding the device.

Attaching the Handstrap

1. Clip the top end of the hand strap to the slot at the top of the device.

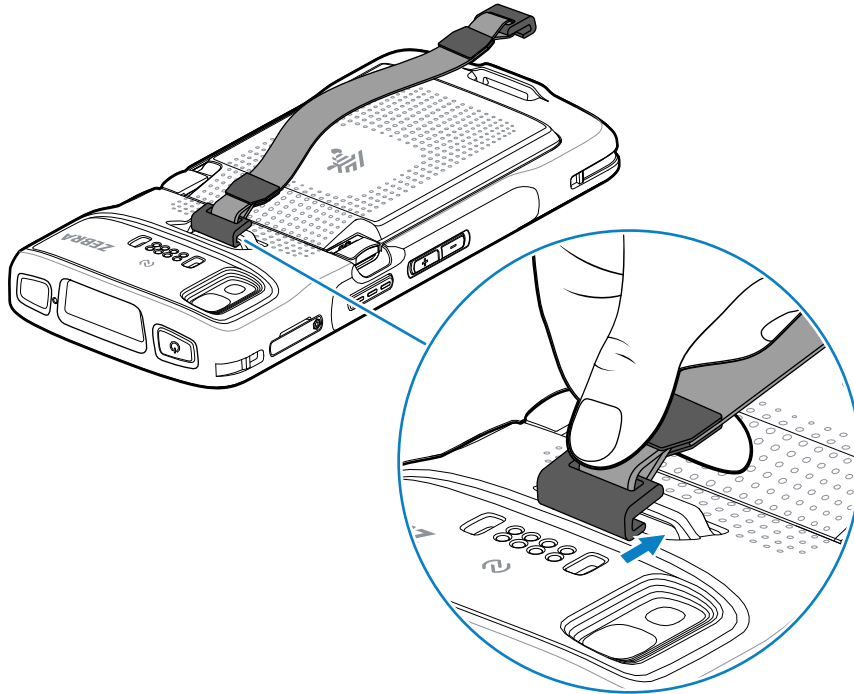

2. Clip the other end of the hand strap into the hand strap slot on the bottom of the device.

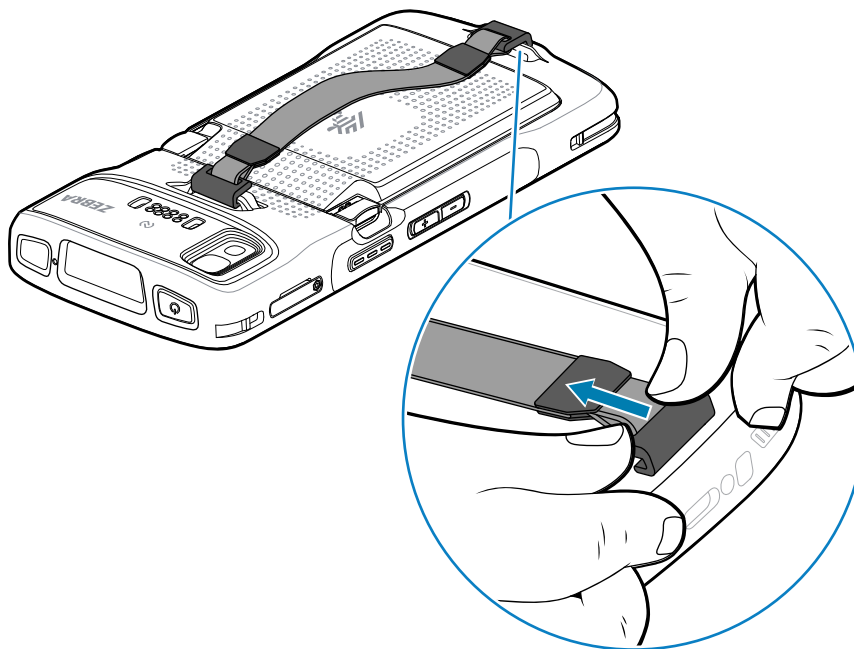

Trigger Handle

The Trigger Handle adds a gun-style handle with a scanning trigger to the device. It increases comfort when using the device in scan-intensive applications for extended periods of time.



NOTE: The Rugged Boot is required to install the Trigger Handle onto the device. Trigger Handle (p/n TRG-TC2L-SNP1-01) does not contain the Rugged Boot and must be purchased separately.

Figure 37 Trigger Handle

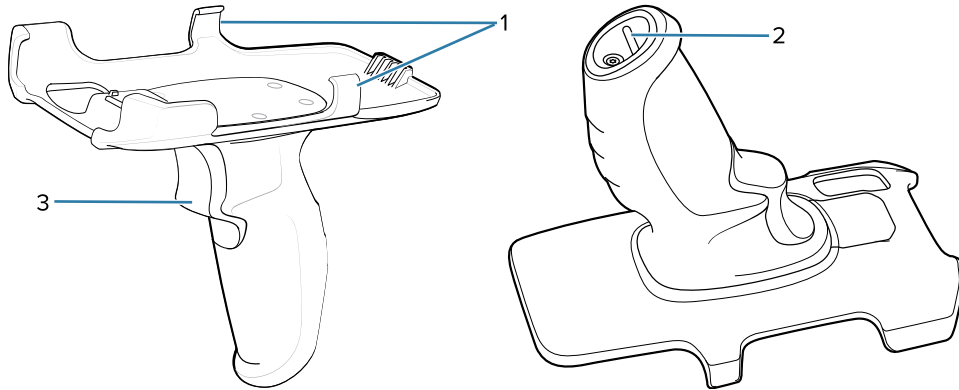

1	Release Tabs
2	Lanyard Mount
3	Trigger

Installing the Optional Lanyard

The optional lanyard attaches to the bottom of the Trigger Handle.

1. Insert the loop end of the tether into the slot on the bottom of the handle.

2. Feed the lanyard through the loop.

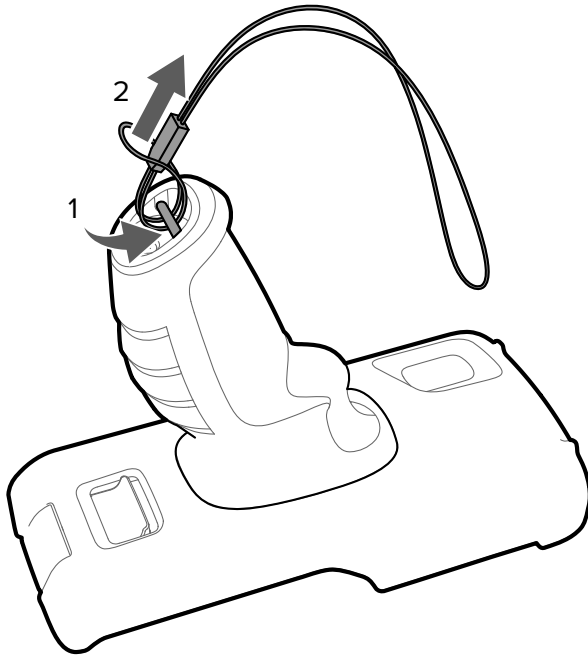

- 3.
4. Pull the lanyard until the loop tightens.
- 5.

Inserting the Device into the Trigger Handle

Before using the trigger handle, insert the device.

1. Align and insert the top of the device into the front of the Trigger Handle.

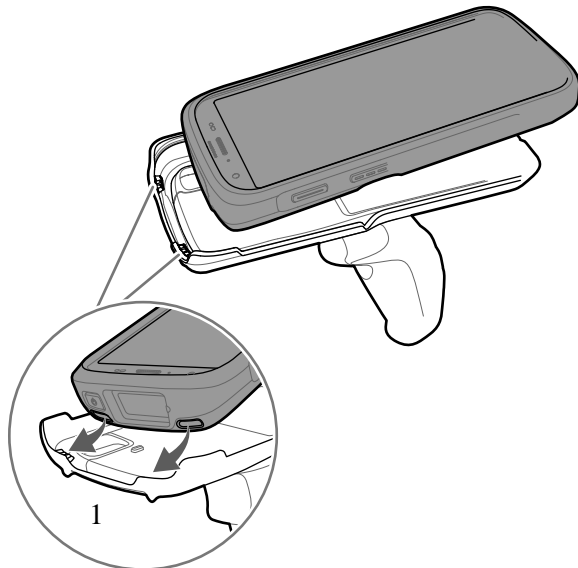

2. Rotate the device down and press down until it snaps into place.

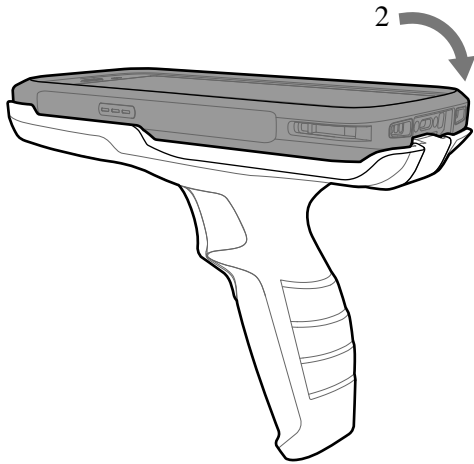

Removing the Device from the Trigger Handle

After using the Trigger Handle, remove the device.

1. On the bottom of the Trigger Handle, press the release latch.

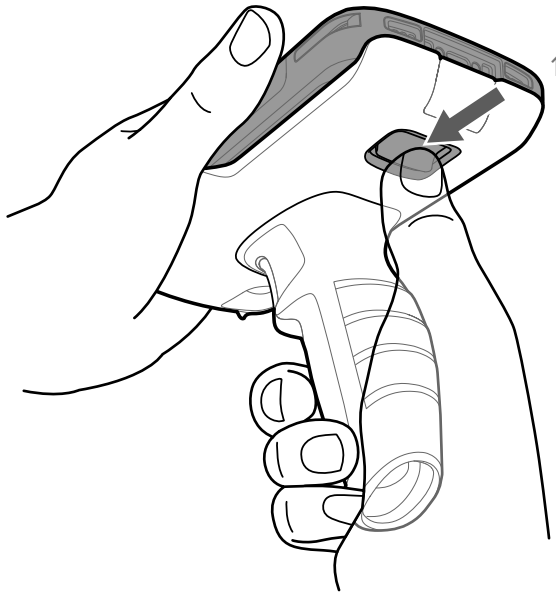

2. Lift the bottom of the device up and remove from the Trigger Handle.

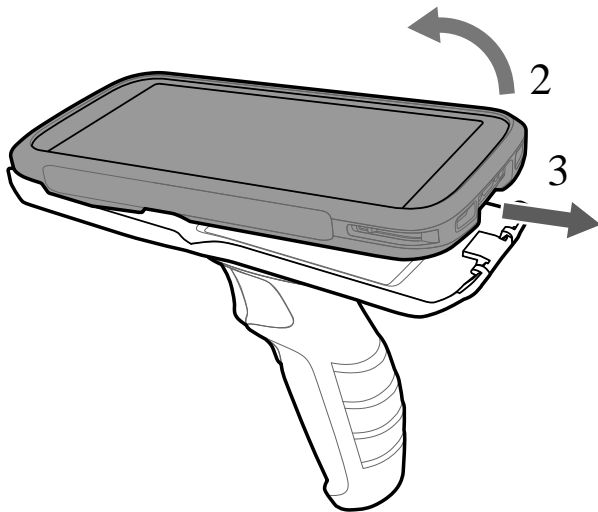

5-Slot Cradle Rack Installation

Use the Rack/Wall Mount Bracket to mount a 5-slot cradle on a rack. When installing on a rack, first assemble the bracket and cradles/chargers and then install the assembly on the rack.

Installing the 5-Slot Cradle on a Rack



NOTE: Ensure tie wrap buckle is on side of power supply. Tie wrap buckle on top of power supply interferes with top tray.

1. Place the power supply in bottom tray.
2. Connect AC line cord to power supply.
3. Connect DC line cord to power supply.
4. Secure power supply and cables to bottom tray with tie wraps.
5. Route cables through cable slots.

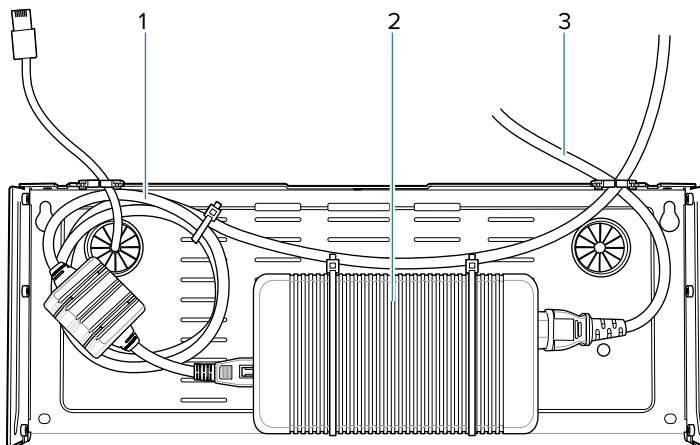

1

DC line cord

2	Power supply
3	AC line cord

6. Secure four M2.5 studs to top tray as shown.

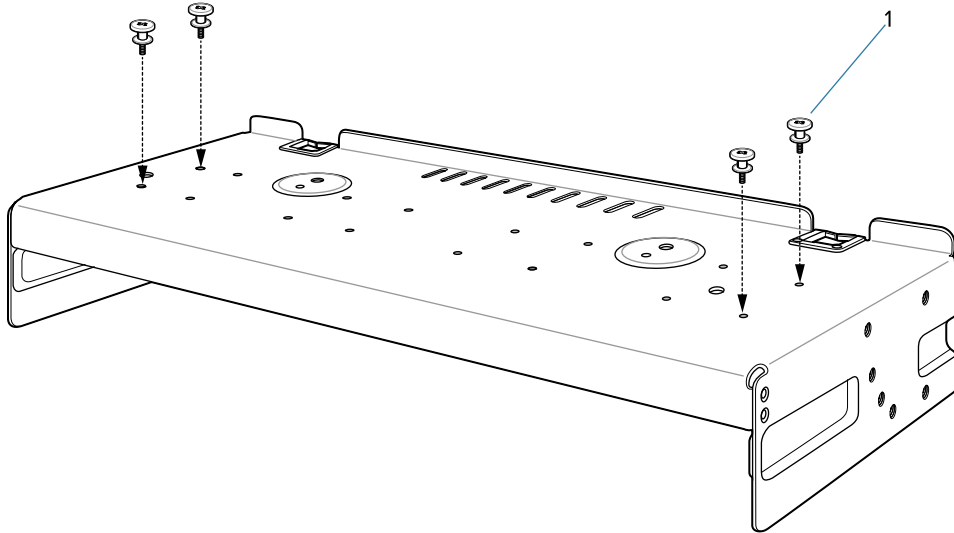

1	Studs (4)
---	-----------

7. Align and install 5-Slot cradle onto studs of top tray.

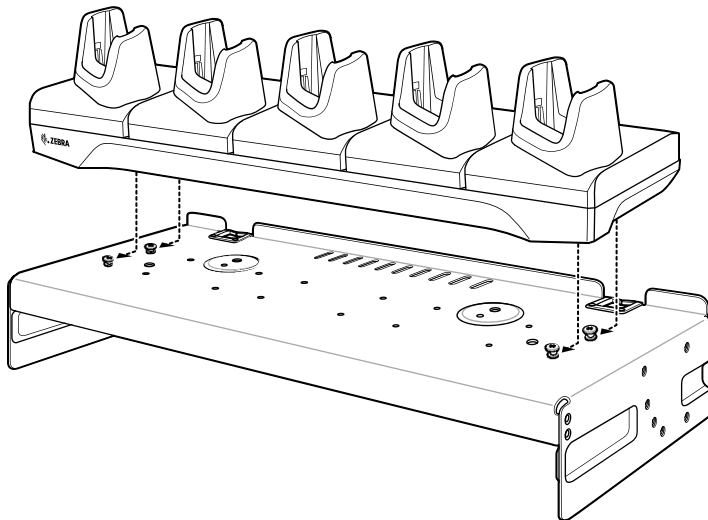

8. Secure cradle to top tray with two M2.5 safety screws.

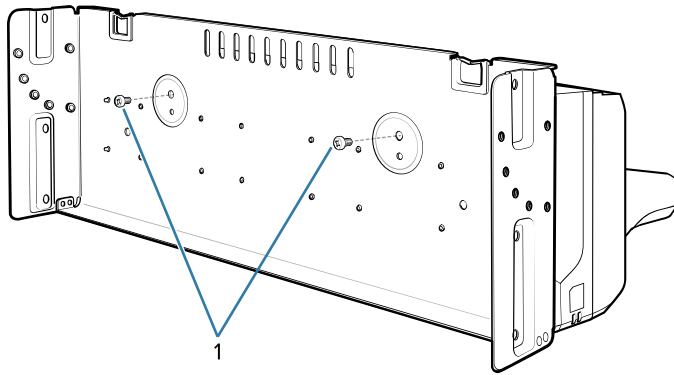

1	Safety Screws(2)
---	------------------

9. Slide top tray onto bottom tray.

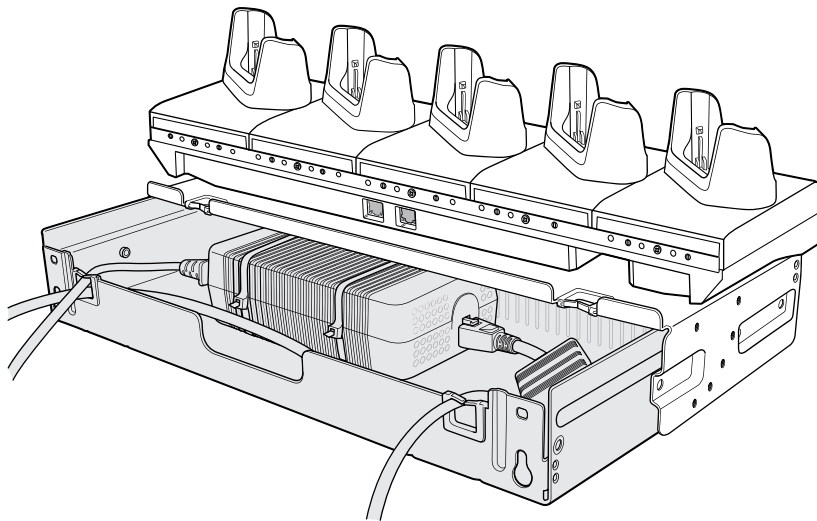

10. Connect cables to cradle.

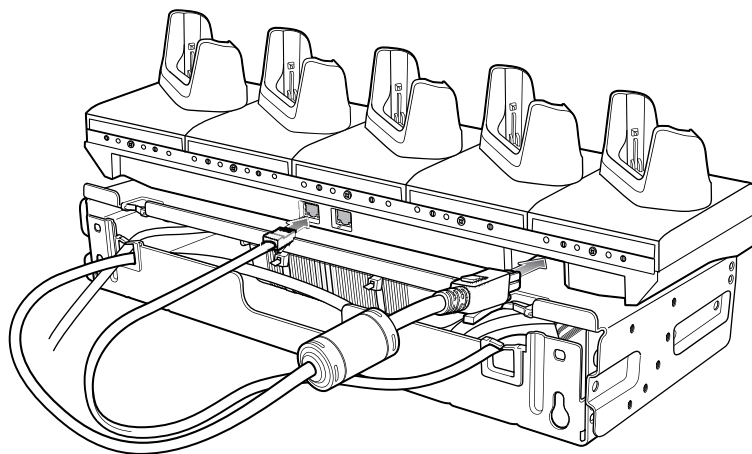

11. Secure top tray to bottom tray with four M5 screws (two on each side).

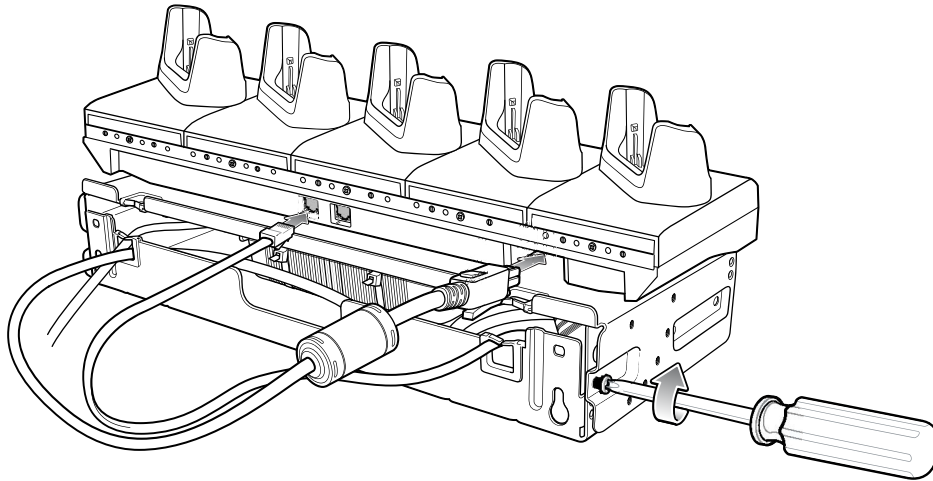

See [Installing the Rack Mount](#) on page 168 for installing the bracket assembly onto a rack.

4-Slot Battery Chargers Rack Installation

Use the Rack/Wall Mount Bracket to mount four 4-Slot Battery Chargers on a rack. When installing on a rack, first assemble the bracket and chargers and then install the assembly on the rack.

Installing 4-Slot Battery Chargers on a Rack

Use the Rack/Wall Mount Bracket to mount four 4-Slot Battery Chargers on a rack. When installing on a rack, first assemble the bracket and chargers and then install the assembly on the rack.

1. Place one power supply horizontally in the bottom tray.
2. Place another power supply vertically in the bottom tray.
3. Connect AC line cords to the power supplies.
4. Connect DC line cords to the power supplies.
5. Secure the power supplies and cables to the bottom tray with tie wraps.

6. Route the cables through the cable slots.

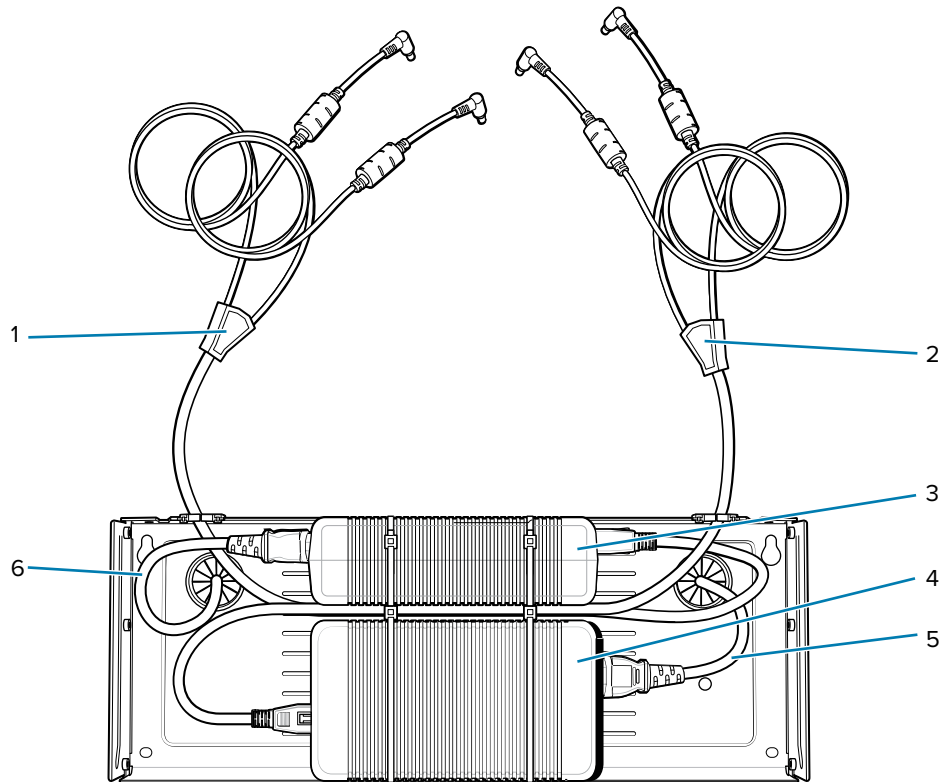

1	DC Y cable 1
2	DC Y cable 2
3	Power supply 1
4	Power supply 2
5	AC line cord 2
6	AC line cord 1

7. Slide the top tray onto the bottom tray until the top tray touches the vertical power supply.

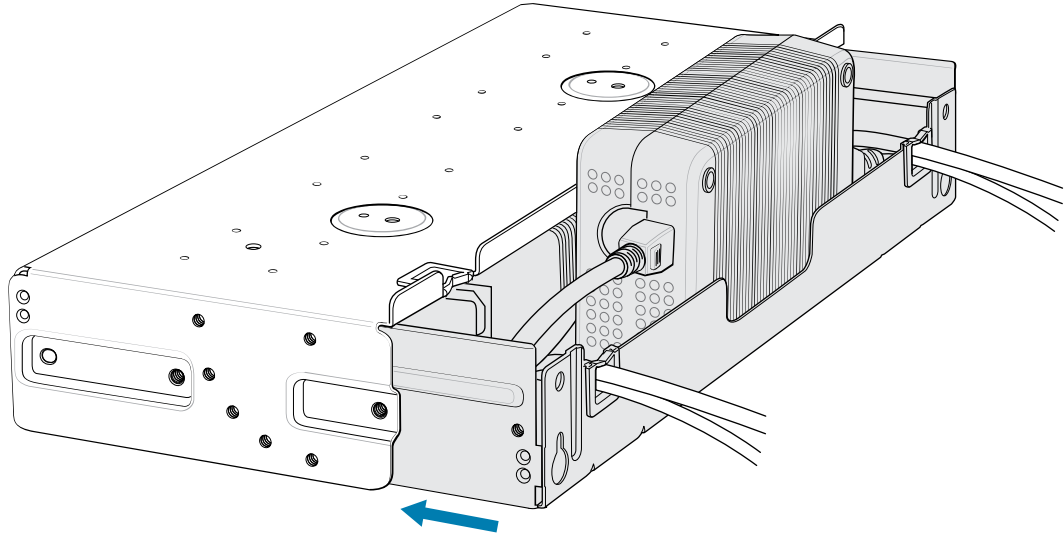

8. Install 16 M2.5 studs onto the top tray as shown.

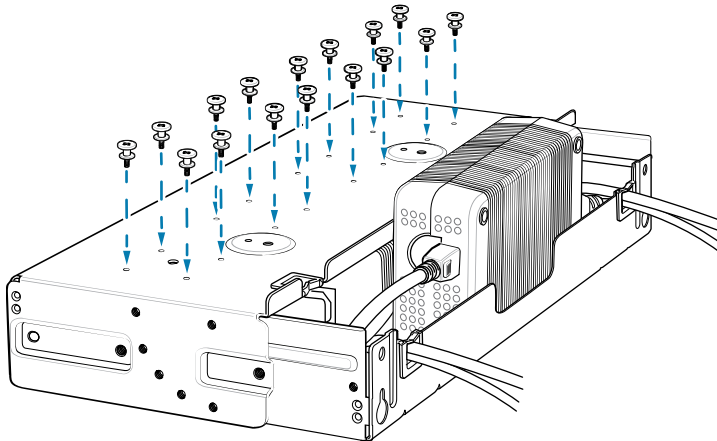

9. Align and install a 4-Slot Battery Charger onto each set of four studs.

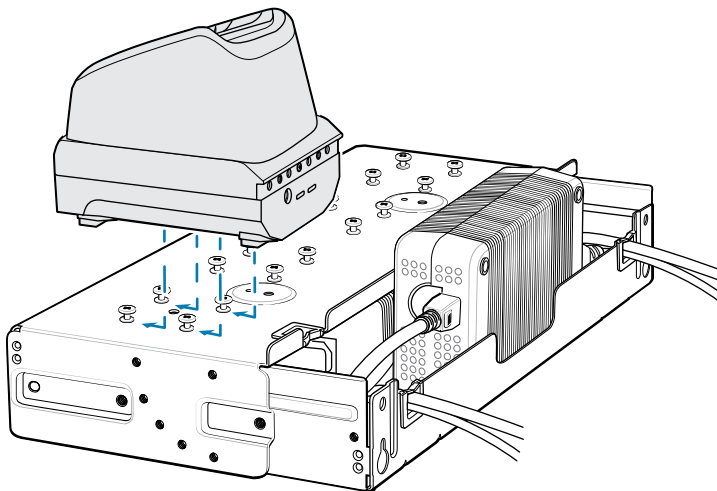

10. Connect DC Y cables to the four 4-Slot Battery Chargers.

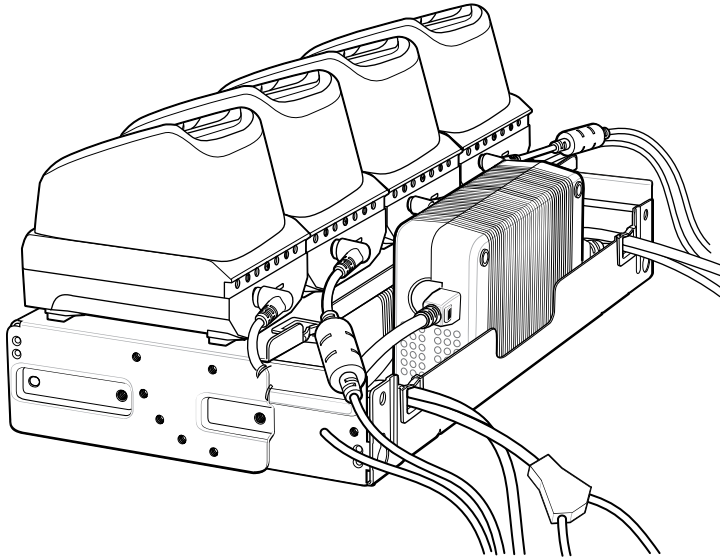

11. Secure the top tray to the bottom tray with four M5 screws (two on each side).

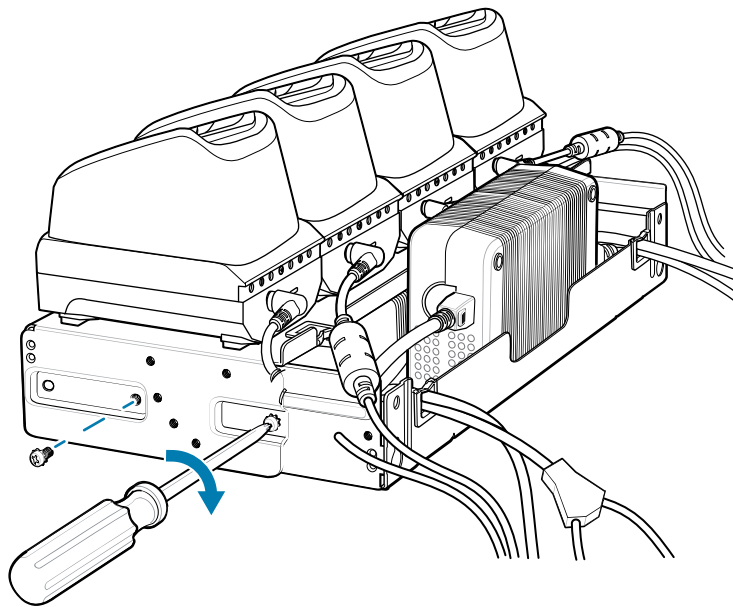

See [Installing the Rack Mount](#) on page 168 for installing the bracket assembly onto a rack.

Installing the Rack Mount



NOTE: Use screws provided with rack system. Refer to rack user documentation for instructions.

While installing the brackets, power supplies and cables:

- Use tie wraps to secure cables to the bracket and rails.
- Coil cables wherever possible.

- Route power cables along the rails.
 - Route inter-cradle cables to the side rails and then from the rails to the bracket.
1. Secure mounting brackets to both sides of top tray with four M5 screws (two on each side).
 - For 5-Slot cradles, position the flange for horizontal installation.

Figure 38 Flange Horizontal Position (5-Slot Cradles)

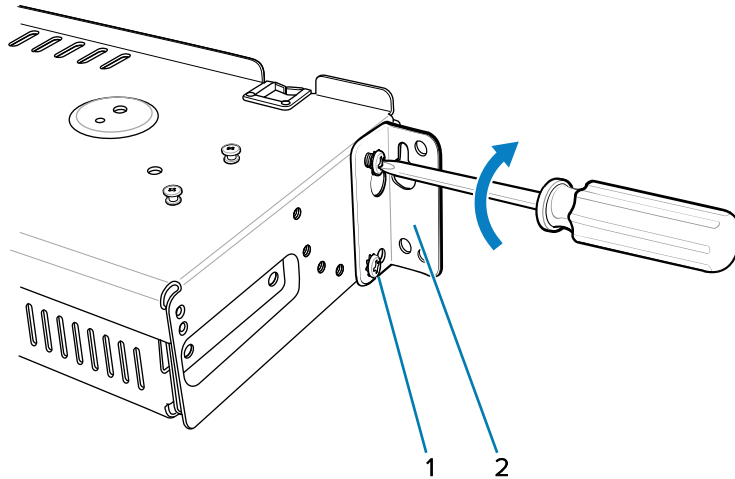

1	Flange
2	Fifth Screw Hole

- For 4-Slot Battery Chargers, position the flange for 25° installation.

Figure 39 Flange 25° Position (4-Slot Battery Chargers)

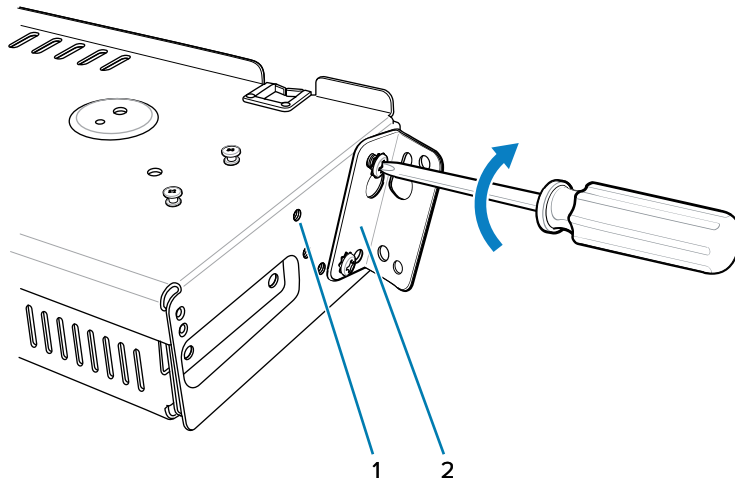

1	Top Screw Hole
---	----------------

2

Flange



CAUTION: Install mounting bracket with 5-Slot cradle at a maximum height of four feet from ground. Install mounting bracket with 4-Slot Battery Charger at a maximum height of three feet from ground.



NOTE: Distance between two horizontal mounted brackets should be at least 14" apart (from top of one flange to the top of the next flange). Distance between a horizontal mounted bracket and a 25° mounted bracket should be at least 16.25" apart (from top of one flange to the top of the next flange). There should be enough clearance (2.75") between the top of the device and the bottom of the mounting bracket above.

2. Install two rack system screws for top of mounting brackets. The screw heads should protrude half way from the rail.

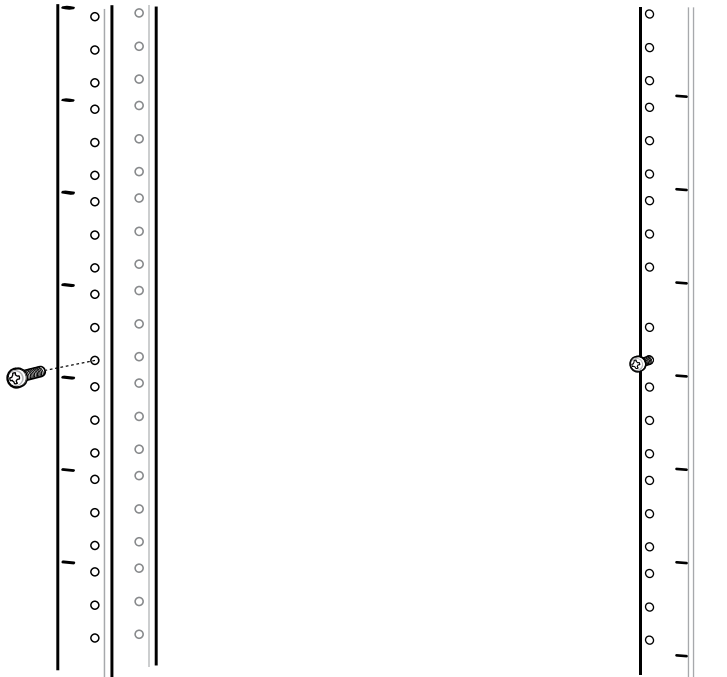

3. Align the mounting bracket's top mounting key holes with the screws.

- Place the brackets on the screws.

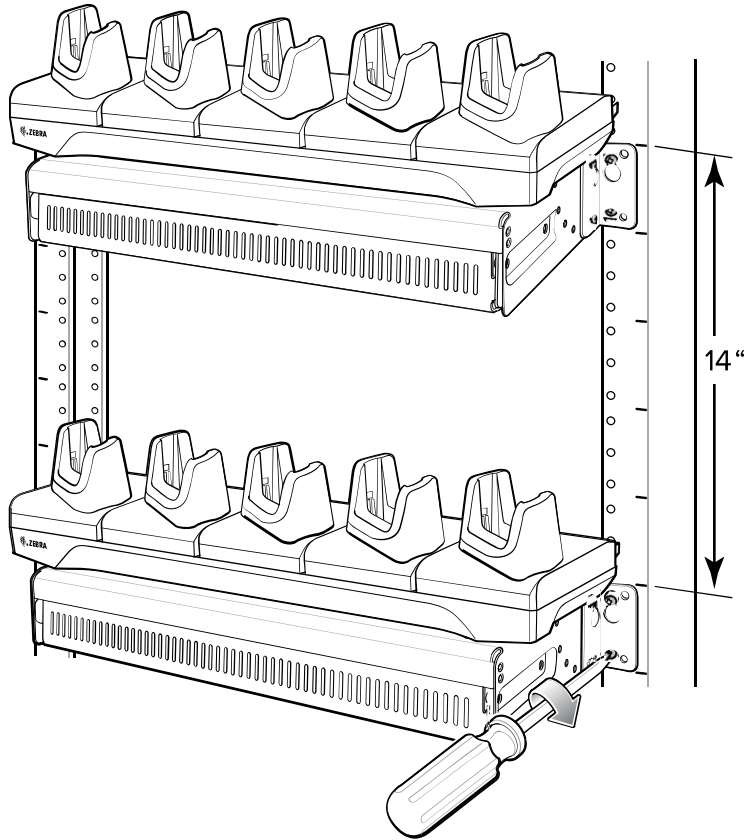

- Secure the top screws.
- Install bottom screws and tighten screws.
- Route cables and connect to power source.



CAUTION: Installer should ensure that all building codes are followed when connecting the power supplies to an AC power source.

Wall Installation

Use the Rack/Wall Mount Bracket to mount four 4-Slot Battery Chargers or a cradle on a wall. When installing on a wall, first assemble the bottom tray, install the bottom tray on the wall and then assemble the top tray.

Use mounting hardware (screws and/or anchors) appropriate for the type of wall mounting the bracket onto. The Mount Bracket mounting slots dimensions are 5 mm (0.2 in.). Fasteners must be able to hold a minimum of 20 Kg (44 lbs.)

For proper installation consult a professional installer. Failure to install the bracket properly can possibly result in damage to the hardware.



CAUTION: Install mounting bracket with 5-Slot cradle at a maximum height of four feet from ground. Install mounting bracket with 4-Slot Battery Charger at a maximum height of three feet from ground.

Bottom Tray Assembly

See steps 1 through 5 on [Installing the 5-Slot Cradle on a Rack](#) on page 162 for instructions.

Mounting the Bracket



CAUTION: The Installer should ensure that all building codes are followed when connecting the power supplies to an AC power source.

While installing the brackets, power supplies and cables:

- Use tie wraps to secure cables to the bracket and rails.
 - Coil cables wherever possible.
 - Route power cables along the rails.
 - Route inter-cradle cables to the side rails and then from the rails to the bracket.
1. Drill holes and install anchors according to the template supplied with the bracket.
 2. Install two screws for bottom of bracket. The screw heads should protrude 2.5 mm (0.01") from the wall.

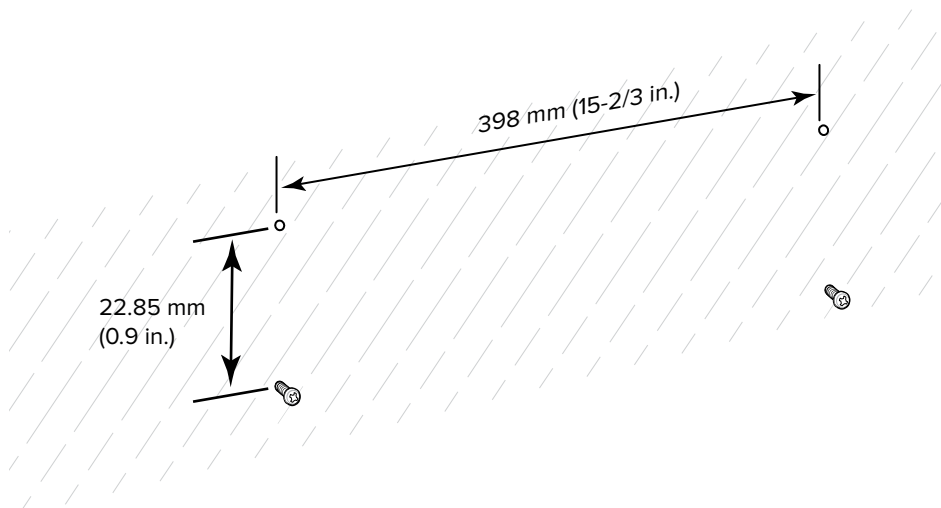

3. Align the mounting bracket's bottom mounting key holes with the screws.

4. Hang the bracket on the screws.

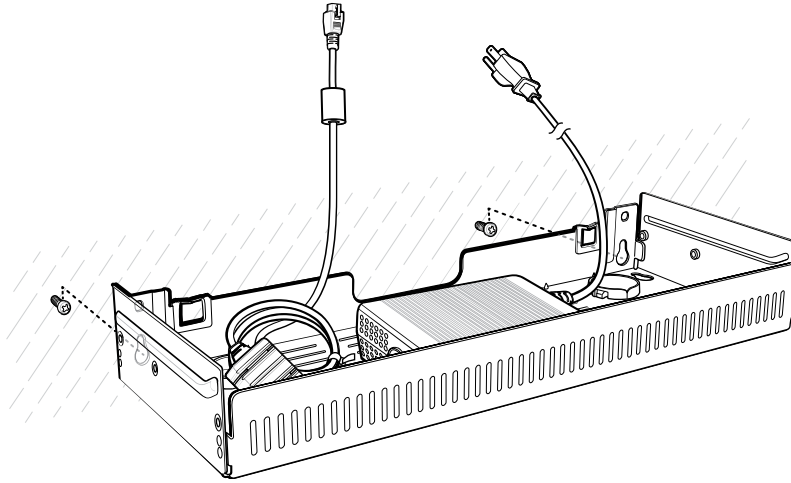

5. Install two top screws.

6. Tighten all screws.

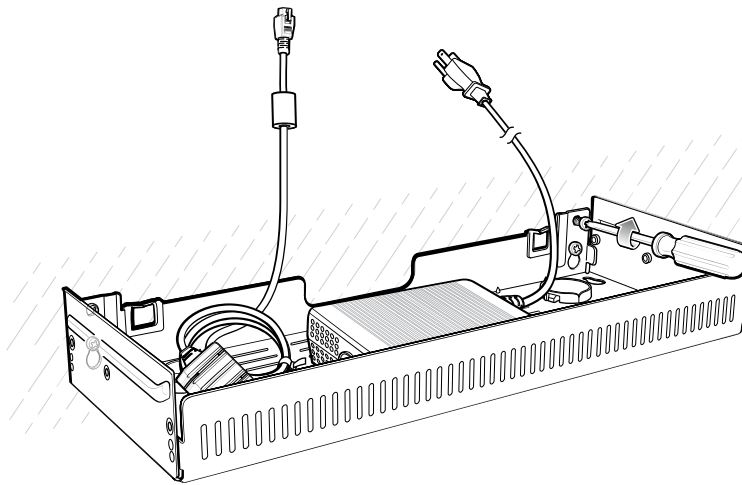

7. Assemble the four 4-Slot Battery Chargers or cradle onto the bracket. See steps 7 through 11 in the section [Installing 4-Slot Battery Chargers on a Rack](#) on page 165.

8. Route cables and connect to power source.

Application Deployment

This section provides steps on device security, app development, and app management. It also provides instructions for installing apps and updating the device software.



NOTE: Ensure that the date is set correctly before installing certificates or when accessing secure websites.

Android Security

The device implements a set of security policies that determine whether an application is allowed to run and, if allowed, with what level of trust. To develop an application, you must know the security configuration of the device, and how to sign an application with the appropriate certificate to allow the application to run (and to run with the needed level of trust).



NOTE: Ensure the date is set correctly before installing certificates or when accessing secure web sites.

Secure Certificates

If the VPN or Wi-Fi networks rely on secure certificates, obtain the certificates and store them in the device's secure credential storage before configuring access to the VPN or Wi-Fi networks.

If downloading the certificates from a web site, set a password for the credential storage. The device supports X.509 certificates saved in PKCS#12 key store files with a .p12 extension (if key store has a .pfx or other extension, change to .p12).

The device also installs any accompanying private key or certificate authority certificates contained in the key store.

Installing a Secure Certificate

If required by the VPN or Wi-Fi network, install a secure certificate on the device.

1. Copy the certificate from the host computer to the root of the microSD card or the device's internal memory.
2. Go to **Settings**.
3. Touch **Security > More security settings > Encryption & credentials**.
4. Touch **Install a certificate**.
5. Select the Credential type, **CA certificate**, **VPN and app user certificate**, or **Wi-Fi certificate**.

6. Navigate to the location of the certificate file.
7. Touch the filename of the certificate to install.
8. If prompted, enter the password for credential storage. If a password has not been set for the credential storage, enter a password for it twice, and then touch **OK**.
9. Touch **OK**.

The certificate can now be used when connecting to a secure network. The certificate is deleted from the microSD card or internal memory for security.

Configuring Credential Storage Settings

Configure credential storage from the device settings.

1. Go to **Settings**.
2. Touch **Security > Encryption & credentials**.
3. Select an option.
 - Touch **Trusted credentials** to display the trusted system and user credentials.
 - Touch **User credentials** to display user credentials.
 - Touch **Install a certificate** to install a secure certificate from the microSD card or internal storage.
 - Touch **Clear credentials** to delete all secure certificates and related credentials.

Android Development Tools

Development tools for Android include Android Studio, EMDK for Android, and StageNow.

Android Development Workstation

Android development tools are available at developer.android.com.

To start developing applications for the device, download Android Studio. Development can take place on a Microsoft® Windows®, Mac® OS X®, or Linux® operating system.

Applications are written in Java or Kotlin, but compiled and executed in the Dalvik virtual machine. Once the Java code is compiled cleanly, the developer tools make sure the application is packaged properly, including the AndroidManifest.xml file.

Android Studio contains a full featured IDE as well as SDK components required to develop Android applications.

Enabling Developer Options

The **Developer options** screen sets development-related settings. By default, the Developer Options are hidden.

1. Go to **Settings**.
2. Touch **About phone**.
3. Scroll down to **Build number**.

4. Tap **Build number** seven times.
The message **You are now a developer!** appears.
5. Touch **Back**.
6. Touch **System > Developer Options**.
7. Slide the **USB debugging** switch to the on position.

EMDK for Android

EMDK for Android provides developers with tools to create business applications for enterprise mobile devices. It is designed for use with Google's Android Studio and includes Android class libraries such as Barcode, sample applications with source code, and the associated documentation.

EMDK for Android allows applications to take full advantage of the capabilities that Zebra devices have to offer. It embeds Profile Manager technology within Android Studio IDE, providing a GUI-based development tool designed specifically for Zebra devices. This allows fewer lines of code, resulting in reduced development time, effort, and errors.

For more information, go to techdocs.zebra.com.

StageNow for Android

StageNow is Zebra's next-generation Android Staging Solution built on the MX platform. It allows quick and easy creation of device profiles and can deploy to devices simply by scanning a barcode or reading a tag.

The StageNow Staging Solution includes the following components:

- The StageNow Workstation tool installs on the staging workstation (host computer) and lets the administrator easily create staging profiles for configuring device components, and perform other staging actions such as checking the condition of a target device to determine suitability for software upgrades or other activities. The StageNow Workstation stores profiles and other created content for later use.
- The StageNow Client resides on the device and provides a user interface for the staging operator to initiate staging. The operator uses one or more of the desired staging methods (print and scan a barcode or read an NFC tag) to deliver staging material to the device.

For more information, go to techdocs.zebra.com.

GMS Restricted

GMS Restricted mode deactivates Google Mobile Services (GMS). All GMS apps are disabled on the device and communication with Google (analytics data collection and location services) is disabled.

Use StageNow to disable or enable GMS Restricted mode. After a device is in GMS Restricted mode, enable and disable individual GMS apps and services using StageNow. To ensure GMS Restricted mode persists after an Enterprise Reset, use the Persist Manager option in StageNow.

For more information on StageNow, go to techdocs.zebra.com.

ADB USB Setup

To use the Android Debug Bridge (ADB), install the development SDK on the host computer then install the ADB and USB drivers.

Before installing the USB driver, make sure that the development SDK is installed on the host computer. Go to developer.android.com/sdk/index.html for details on setting up the development SDK.

The ADB and USB drivers for Windows and Linux are available on the Zebra Support Central web site at zebra.com/support. Download the ADB and USB Driver Setup package. Follow the instructions with the package to install the ADB and USB drivers for Windows and Linux.

Enabling USB Debugging

By default, USB debugging is disabled.

1. Go to **Settings**.
2. Touch **About phone**.
3. Scroll down to **Build number**.
4. Tap **Build number** seven times.
The message **You are now a developer!** appears.
5. Touch **Back**.
6. Touch **System > Developer options**.
7. Slide the **USB debugging** switch to the **ON** position.
8. Touch **OK**.
9. Connect the device to the host computer using the Rugged Charge/USB Cable.

The **Allow USB debugging?** dialog box appears on the device.

If the device and host computer are connected for the first time, the **Allow USB debugging?** dialog box with the **Always allow from this computer** check box displays. Select the check box, if required.

10. Touch **OK**.
11. On the host computer, navigate to the **platform-tools** folder and open a command prompt window.
12. Type `adb devices`.

The following displays:

```
List of devices attached          XXXXXXXXXXXXXXXXXXXX device
```

Where XXXXXXXXXXXXXXXXXXXX is the device number.



NOTE: If device number does not appear, ensure that ADB drivers are installed properly.

Entering Android Recovery Manually

Many of the update methods discussed in this section require putting the device into Android Recovery mode. If you are unable to enter Android Recovery mode through adb commands, use the following steps to manually enter Android Recovery mode.

1. Press and hold the Power button until the menu appears.
2. Touch **Restart**.
3. Press and hold the PTT button until the device vibrates.

The System Recovery screen appears.

Application Installation Methods

After an application is developed, install the application onto the device using one of the supported methods.

- USB connection
- Android Debug Bridge
- microSD Card
- Mobile device management (MDM) platforms that have application provisioning. Refer to the MDM software documentation for details.

Installing Applications Using the USB Connection

Use the USB connection to install applications onto the device.



CAUTION: When connecting the device to a host computer and mounting the microSD card, follow the host computer's instructions for connecting and disconnecting USB devices, to avoid damaging or corrupting files.



NOTE: This method is not recommended due to limited Internal Storage.

1. Connect the device to a host computer using the USB-C cable.
2. On the device, pull down the Notification panel and touch **Charging this device via USB**.
By default, **No data transfer** is selected.
3. Touch **File Transfer**.
4. On the host computer, open a file explorer application.
5. On the host computer, copy the application APK file from the host computer to the device.
6. Disconnect the device from the host computer.
7. Swipe the screen up and select  to view files on the Internal Storage.
8. Locate the application APK file.
9. Touch the application file.
10. Touch **Continue** to install the app or **Cancel** to stop the installation.
11. To confirm installation and accept what the application affects, touch **Install** otherwise touch **Cancel**.

12. Touch **Open** to open the application or **Done** to exit the installation process.
The application appears in the App list.

Installing Applications Using the Android Debug Bridge

Use ADB commands to install applications onto the device.

1. Ensure that the ADB drivers are installed on the host computer.
2. Connect the device to a host computer using a USB cable.
3. Go to **Settings**.
4. Touch **System > Developer options**.
5. Touch the **USB debugging** toggle to enable it.
The **Allow USB debugging?** message appears.
6. Touch **OK**.
7. On the host computer, navigate to the **platform-tools** folder and open a command prompt window.
8. Type `adb install <application>`.
where: <application> = the path and filename of the apk file.
9. Disconnect the device from the host computer.

Installing Applications Using Wireless ADB

Use ADB commands to install an application onto the device.

Go to the Zebra Support & Downloads web site at zebra.com/support and download the appropriate file to a host computer.



IMPORTANT: Note the following:

- Ensure that the latest adb files are installed on the host computer.
 - The device and the host computer must be on the same wireless network.
1. Go to **Settings**.
 2. Touch **System > Developer options**.
 3. Slide the **USB debugging** switch to the **ON** position.
 4. Slide the **Wireless debugging** switch to the **ON** position.
 5. If the device and host computer are connected for the first time, the **Allow wireless debugging on this network?** dialog box with the **Always allow from this network** check box displays. Select the check box, if required.
 6. Touch **ALLOW**.
 7. Touch **Wireless debugging**.

8. Touch **Pair with pairing code**.

The **Pair with device** dialog box displays.

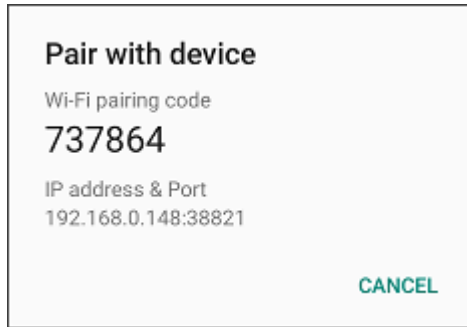

9. On the host computer, navigate to the **platform-tools** folder and open a command prompt window.
10. Type `adb pair XX.XX.XX.XX.XXXXX`,
where `XX.XX.XX.XX:XXXXX` is the IP address and port number from the **Pair with device** dialog box.
11. Type: `adb connect XX.XX.XX.XX.XXXXX`
12. Press **Enter**.
13. Type the pairing code from the **Pair with device** dialog box.
14. Press **Enter**.
15. Type `adb connect`.
The device is now connected to the host computer.
16. Type `adb devices`.
The following displays:

```
List of devices attached          XXXXXXXXXXXXXXXXXXXX device
```

Where XXXXXXXXXXXXXXXXXXXX is the device number.



NOTE: If device number does not appear, ensure that ADB drivers are installed properly.

17. On the host computer command prompt window type:

```
adb install <application>
```

18. On the host computer, type:



```
adb disconnect.
```

Installing Applications Using a microSD Card

Use a microSD card to install applications on your device.



CAUTION—PRODUCT DAMAGE: When connecting the device to a host computer and mounting the microSD card, follow the host computer's instructions for connecting and disconnecting USB devices, to avoid damaging or corrupting files.

1. Copy the APK file to the root of the microSD card.
 - Copy the APK file to a microSD card using a host computer (see USB Communication for more information), and then install the microSD card into the device (see Replacing the microSD Card for more information).
 - Connect the device with a microSD card already installed to the host computer, and copy the .apk file to the microSD card. See USB Communication for more information. Disconnect the device from the host computer.
2. Connect the device to a host computer using USB.
3. Copy the application APK file from the host computer to the microSD card.
4. Remove the microSD card from the host computer.
5. Press and hold the Power button on the device until the menu appears.
6. Touch **Power off**.
7. Remove the card holder.
8. Insert the microSD card into the card holder.
9. Replace the card holder.
10. Press and hold **Power** to turn on the device.
11. Swipe the screen up and select  to view files on the microSD card.
12. Touch  **SD card**.
13. Locate the application APK file.
14. Touch the application file.
15. Touch **Continue** to install the app or **Cancel** to stop the installation.
16. To confirm installation and accept what the application affects, touch **Install**. Otherwise, touch **Cancel**.
17. Touch **Open** to open the application or **Done** to exit the installation process.

The application appears in the App list.

Uninstalling an Application

Free up device memory by removing unused apps.

1. Go to **Settings**.
2. Touch **Apps**.
3. Touch **See all apps** to view all apps in the list.
4. Scroll through the list to the app.
5. Touch the app.

The **App info** screen displays.
6. Touch **Uninstall**.
7. Touch **OK** to confirm.

Android System Update

System Update packages can contain either partial or complete updates for the operating system. Zebra distributes the System Update packages on the Zebra Support & Downloads website. Perform a system update using either a microSD card or using ADB.

Performing a System Update Using a microSD Card

It is strongly recommended that, prior to use, you format the microSD card on the device.

1. Copy the System Update zip file to the root of the microSD card.
 - Copy the ZIP file to a microSD card using a host computer, and then install the microSD card into the device. See [Installing a microSD Card](#) on page 21.
 - Connect the device with a microSD card already installed to the host computer, copy the ZIP file to the microSD card, and then disconnect the device from the host computer.
2. Press and hold **Power** until the menu appears.
3. Touch **Restart**.
4. Press and hold **PTT** until the device vibrates.

The System Recovery screen appears.
5. Press **Volume Up** and **Volume Down** to navigate to **Apply upgrade from SD card**.
6. Press **Power**.
7. Press **Volume Up** and **Volume Down** to navigate to the System Update file.
8. Press **Power**.

The System Update installs, and then the device returns to the Recovery screen.
9. Press **Power** to reboot the device.

Performing a System Update Using ADB

Use ADB to perform a system update.

Go to the Zebra Support & Downloads web site at zebra.com/support and download the appropriate System Update package to a host computer.



NOTE: If you are not able to enter Android Recovery mode through the adb command, see [Entering Android Recovery Manually](#) on page 178.

1. Connect the device to a host computer using a USB cable.
2. Go to **Settings**.
3. Touch **System > Developer options**.
4. Slide the **USB debugging** switch to the **ON** position.
5. If the device and host computer are connected for the first time, the **Allow USB debugging?** dialog box with the **Always allow from this computer** check box displays. Select the check box, if required.
6. Touch **OK**.

7. Type `adb devices`.
If the device number does not appear, ensure that the ADB drivers are installed properly.
8. Type `adb reboot recovery`.
9. Press **Enter**.
The System Recovery screen displays on the device.
10. Press **Up Arrow** and **Down Arrow** to navigate to **Apply upgrade from ADB**.
11. Press **Enter**.
The System Recovery screen displays on the device.
12. On the host computer command prompt window type `adb sideload <file>`.
where: <file> = the path and filename of the zip file.
13. Press **Enter**.
The System Update installs (the progress displays as a percentage in the Command Prompt window) and then the System Recovery screen displays on the device.
14. Navigate to **Reboot system now** and press the Enter key or Power button to reboot the device.

Verifying System Update Installation

Verify that the system update was successful.

1. Go to **Settings**.
2. Touch **About phone**.
3. Scroll down to **Build number**.
4. Ensure that the build number matches the new system update package file number.

Android Enterprise Reset

An Enterprise Reset erases all user data in the /data partition, including data in the primary storage locations (/sdcard and emulated storage), while preserving the contents of the /enterprise folder and its subfolders. The contents of the /enterprise folder and its subfolders are preserved. Zebra distributes the Enterprise Reset packages on the Zebra Support & Downloads website.

Before performing an Enterprise Reset, provision all necessary configuration files and restore after the reset.

Performing an Enterprise Reset From Device Settings

Perform an Enterprise Reset from the device settings.

1. Go to **Settings**.
2. Touch **System > Reset Options > Erase all data (enterprise reset)**.
3. Touch **Erase all data** twice to confirm the Enterprise Reset.

Performing an Enterprise Reset Using microSD Card

It is strongly recommended that, prior to use, you format the microSD card on the device.

Go to the Zebra Support & Downloads web site at zebra.com/support and download the appropriate Enterprise Reset file to a host computer.

1. Copy the Enterprise Reset zip file to the root of the microSD card.
 - Copy the zip file to a microSD card using a host computer and then install the microSD card into the device. See [Installing a microSD Card](#) on page 21.
 - Connect the device with a microSD card already installed to the host computer and copy zip file to the microSD card. See [USB Communication](#) for more information. Disconnect the device from the host computer.
2. Press and hold **Power** until the menu appears.
3. Touch **Restart**.
4. Press and hold **PTT** until the device vibrates.

The System Recovery screen appears.
5. Press **Volume Up** and **Volume Down** to navigate to **Apply upgrade from SD card**.
6. Press **Power**.
7. Press **Volume Up** and **Volume Down** to navigate to the Enterprise Reset file.
8. Press **Power**.

The Enterprise Reset occurs and then the device returns to the Recovery screen.
9. Press **Power** to reboot the device.

Performing an Enterprise Reset Using ADB

Perform an Enterprise Reset using ADB.



NOTE: If you are not able to enter Android Recovery mode through the adb command, see [Entering Android Recovery Manually](#) on page 178.

1. Connect the device to a host computer using a USB cable.
2. Go to **Settings**.
3. Touch **System > Developer options**.
4. Slide the **USB debugging** switch to the **ON** position.
5. If the device and host computer are connected for the first time, the **Allow USB debugging?** dialog box with the **Always allow from this computer** check box displays. Select the check box, if required.
6. Touch **OK**.
7. On the host computer, navigate to the **platform-tools** folder and open a command prompt window.
8. Type `adb reboot recovery`.
9. Press **Volume Up** and **Volume Down** to navigate to **Apply upgrade from ADB**.
10. Press **Power**.

11. On the host computer command prompt window type `adb sideload <file>`
where: <file> = the path and filename of the zip file.
12. Press **Enter**.
The Enterprise Reset package installs and then the System Recovery screen appears on the device.
13. Press **Power** to reboot the device.

Android Factory Reset

A Factory Reset erases all data in the /data and /enterprise partitions in internal storage and clears all device settings. A Factory Reset returns the device to the last installed operating system image. To revert to a previous operating system version, re-install that operating system image. Zebra distributes the Factory Reset packages on the Zebra Support & Downloads website.

Performing a Factory Reset Using microSD Card

Perform a Factory Reset using a microSD card.

Go to the Zebra Support & Downloads website at zebra.com/support and download the appropriate Factory Reset file to a host computer.

1. Copy the Factory Reset zip file to the root of the microSD card.
 - Copy the zip file to a microSD card using a host computer and then installing the microSD card into the device. See [Installing a microSD Card](#) on page 21.
 - Connect the device with a microSD card already installed to the host computer, copy zip file to the microSD card, and then disconnect the device from the host computer.
2. Press and hold **Power** until the menu appears.
3. Touch **Restart**.
4. Press and hold **PTT** until the device vibrates.
The System Recovery screen appears.
5. Press **Volume Up** and **Volume Down** to navigate to **Apply upgrade from SD card**.
6. Press **Power**.
7. Use **Volume Up** and **Down Arrow** to navigate to the Factory Reset file.
8. Press **Power**.
The Factory Reset occurs, and then the device returns to the Recovery screen.
9. Press **Power** to reboot the device.

Performing a Factory Reset Using ADB

Perform a Factory Reset using ADB.

Go to the Zebra Support & Downloads website at zebra.com/support and download the appropriate Factory Reset file to a host computer.



NOTE: If you are not able to enter Android Recovery mode through the adb command, see [Entering Android Recovery Manually](#) on page 178.

1. Connect the device to a host computer using a USB cable.
2. Go to **Settings**.
3. Touch **System > Developer options**.
4. Slide the **USB debugging** switch to the **ON** position.
5. If the device and host computer are connected for the first time, the **Allow USB debugging?** dialog box with the **Always allow from this computer** check box displays. Select the check box, if required.
6. Touch **OK**.
7. On the host computer, navigate to the **platform-tools** folder and open a command prompt window.
8. Type `adb reboot recovery`.
9. Press **Enter**.
The System Recovery screen appears on the device.
10. Press **Volume Up** and **Volume Down** buttons to navigate to **Apply upgrade from ADB**.
11. Press **Power**.
12. On the host computer command prompt window type `adb sideload <file>`.
where: <file> = the path and filename of the zip file.
13. Press **Enter**.
The Factory Reset package installs, and then the System Recovery screen appears on the device.
14. Press **Power** to reboot the device.

Android Storage

The device contains multiple types of file storage.

- Random Access Memory (RAM)
- Internal storage
- External storage (microSD card)
- Enterprise folder.



NOTE: It is recommended to install a microSD card on the device due to limited internal storage space.

Random Access Memory

Executing programs use RAM to store data. Data stored in RAM is lost upon a reset.

The operating system manages how applications use RAM. It only allows applications and component processes and services to use RAM when required. It may cache recently used processes in RAM, so they restart more quickly when opened again, but it will erase the cache if it needs the RAM for new activities.

The screen displays the amount of used and free RAM.

- **Performance** - Indicates memory performance.
- **Total memory** - Indicates the total amount of RAM available.

- **Average used (%)** - Indicates the average amount of memory (as a percentage) used during the period of time selected (default - 3 hours).
- **Free** - Indicates the total amount of unused RAM.
- **Memory used by apps** - Touch to view RAM usage by individual apps.

Viewing Memory

View the amount of memory used and free RAM.

1. Go to **Settings**.
2. Touch **System > Developer options**.
3. Touch **Memory**.

Internal Storage

The device has internal storage. The internal storage content can be viewed and files copied to and from when the device is connected to a host computer. Some applications are designed to be stored on the internal storage rather than in internal memory.

Viewing Internal Storage

View available and used internal storage on the device.

1. Go to **Settings**.
2. Touch **Storage**.

It displays the total amount of space on internal storage and amount used.

If the device has removable storage installed, touch **Internal shared storage** to display the amount of internal storage used by apps, photos, videos, audio, and other files.

External Storage

The device can have a removable microSD card. The microSD card content can be viewed and files copied to and from when the device is connected to a host computer.

Viewing External Storage

Portable storage displays the total amount of space on the installed microSD card and the amount used.

1. Go to **Settings**.
2. Touch **Storage**.
Touch **SD card** to view the contents of the card.
3. To unmount the microSD card, touch .

Formatting a microSD Card as Portable Storage

Format a microSD card as portable storage for the device.

1. Touch **SD card**.

2. Touch **⋮** > **Storage settings**.
3. Touch **Format**.
4. Touch **ERASE & FORMAT**.
5. Touch **DONE**.

Formatting a microSD Card as Internal Memory

You can format a microSD card as internal memory to increase the actual amount of the device's internal memory. Once formatted, the microSD card can only be read by this device.



NOTE: The suggested maximum SD card size is 128 GB when using internal storage.

1. Touch **SD card**.
2. Touch **⋮** > **Storage settings**.
3. Touch **Format as internal**.
4. Touch **ERASE & FORMAT**.
5. Touch **DONE**.

Enterprise Folder

The Enterprise folder (within internal flash) is a super-persistent storage that is persistent after a reset and an Enterprise Reset.

The Enterprise folder is erased during a Factory Reset. The Enterprise folder is used for deployment and device-unique data. The Enterprise folder is approximately 128 MB (formatted). Applications can persist data after an Enterprise Reset by saving data to the enterprise/user folder. The folder is ext4 formatted and is only accessible from a host computer using ADB or from an MDM.

Managing Apps

Apps use two kinds of memory: storage memory and RAM. Apps use storage memory for themselves and any files, settings, and other data they use. They also use RAM when they are running.

1. Go to **Settings**.
2. Touch **Apps**.
3. Touch **See all XX apps** to view all apps on the device.
4. Touch **⋮** > **Show system** to include system processes in the list.
5. Touch an app, process, or service in the list to open a screen with details about it and, depending on the item, to change its settings, permissions, and notifications and to force stop or uninstall it.

App Details



Apps have different kinds of information and controls.

- **Force stop** - Stop an app.
- **Disable** - Disable an app.

- **Uninstall** - Remove the app and all of its data and settings from the device.
- **Notifications** - Set the app notification settings.
- **Permissions** - Lists the areas on the device that the app has access to.
- **Storage & cache** - Lists how much information is stored and includes buttons for clearing it.
- **Mobile data & Wi-Fi** - Provides information about data consumed by an app.
- **Advanced**
 - **Screen time** - Displays the amount of time the app has displayed on the screen.
 - **Battery** - Lists the amount of computing power used by the app.
 - **Open by default** - If you have configured an app to launch certain file types by default, you can clear that setting here.
 - **Display over other apps** - Allows an app to display on top of other apps.
 - **App details** - Provides a link to additional app details on the Play store.
 - **Additional settings in the app** - Opens settings in the app.
 - **Modify system settings** - Allows an app to modify the system settings.

Managing Downloads

Files and apps downloaded using the Browser or Email are stored on the microSD card or Internal storage in the Download directory. Use the Downloads app to view, open, or delete downloaded items.

1. Swipe the screen up and touch .
2. Touch  > **Downloads**.
3. Touch and hold an item to delete, and then touch .

The item is deleted from the device.

Maintenance and Troubleshooting

This section includes instructions on cleaning and storing the device, and provides troubleshooting solutions for potential problems during operation.

Maintaining the Device

Follow these guidelines to maintain the device properly.

For trouble-free service, observe the following tips when using the device:

- To avoid scratching the screen, use a Zebra-approved, capacitive-compatible stylus intended for use with a touch-sensitive screen. Never use an actual pen, pencil, or other sharp object on the surface of the device screen.
- The device's touch-sensitive screen is made of glass. Do not drop the device or subject it to strong impact.
- Protect the device from temperature extremes. Do not leave it on the dashboard of a car on a hot day, and keep it away from heat sources.
- Do not store the device in any dusty, damp, or wet location.
- Use a soft lens cloth to clean the device. If the surface of the device screen becomes soiled, clean it with a soft cloth moistened with an approved cleanser.
- Periodically replace the rechargeable battery to ensure maximum battery life and product performance. Battery life depends on individual usage patterns.
- A screen protector is available for the device. Zebra recommends using a screen protector to minimize wear and tear. Screen protectors enhance the usability and durability of touch screen displays. Benefits include:
 - Protection from scratches and gouges
 - Durable writing and touch surface with tactile feel
 - Abrasion and chemical resistance
 - Glare reduction
 - Keeping the device's screen looking new
 - Quick and easy installation.

Battery Safety Guidelines

To use the device safely, you must follow the battery guidelines.

- The area in which the units are charged should be clear of debris and combustible materials or chemicals. Particular care should be taken when the device is charged in a non-commercial environment.
- Follow the battery usage, storage, and charging guidelines found in this guide.
- To charge the mobile device battery, the ambient battery and charger temperatures must be between 5° C and 40° C (41° F and 104° F).
- Do not use incompatible batteries and chargers, including non-Zebra batteries and chargers. Use of an incompatible battery or charger may present a risk of fire, explosion, leakage, or other hazard. If you have any questions about the compatibility of a battery or a charger, contact the Global Customer Support Center.
- For devices that utilize a USB port as a charging source, the device shall only be connected to products that bear the USB-IF logo or have completed the USB-IF compliance program.
- To enable authentication of an approved battery, as required by IEEE1725 clause 10.2.1, all batteries will carry a hologram. Do not fit any battery without checking if it has the authentication hologram.
- Do not disassemble, open, crush, bend, deform, puncture, or shred the battery.
- Severe impact from dropping any battery-operated device on a hard surface could cause the battery to overheat.
- Do not short-circuit a battery or allow metallic or conductive objects to contact the battery terminals.
- Do not modify or remanufacture, attempt to insert foreign objects into the battery, immerse or expose to water or other liquids, or expose to fire, explosion, or other hazard.
- Do not leave or store the equipment in or near areas that might get very hot, such as in a parked vehicle or near a radiator or other heat source. Do not place a battery into a microwave oven or dryer.
- Battery usage by children should be supervised.
- Please follow local regulations to properly dispose of used rechargeable batteries.
- Do not dispose of batteries in a fire.
- In the event of a battery leak, do not allow the liquid to come in contact with the skin or eyes. If contact has been made, wash the affected area with water for 15 minutes, and seek medical advice.
- If you suspect damage to your equipment or battery, contact Customer Support to arrange for inspection.

Best Practices for Enterprise Mobile Computing Devices Operating in Hot Environments and Direct Sunlight

Exceeding the operating temperature by external hot environments will cause the device's thermal sensor to notify the user of a shutdown of the WAN modem or shutdown the device until the device's temperature returns to the operational temperature range.

- Avoid direct sunlight to the device - The easiest way to prevent overheating is to keep the device out of direct sunlight. The device absorbs light and heat from the sun and retains it, getting hotter the longer it remains in sunlight and heat.

- Avoid leaving the device in a vehicle on a hot day or hot surface - Similar to leaving the device out in direct sunlight, the device will also absorb the thermal energy from a hot surface or when left on the dashboard of a vehicle or seat, getting warmer the longer it remains on the hot surface or inside the hot vehicle.
- Turn off unused apps on the device. Open, unused apps running in the background can cause the device to work harder, which in turn may cause it to heat up. This will also improve your mobile computer device's battery life performance.
- Avoid turning your screen brightness up - Just the same as running background apps, turning your brightness up will force your battery to work harder and create more heat. Minimizing your screen brightness may extend operating the mobile computer device in hot environments.

Properly Plugging and Unplugging a USB-C Cable

This section outlines the proper procedures for safely connecting and disconnecting a USB Type-C cable to prevent damage to the device's connector port.

When connecting/disconnecting the cable from your device:

- Visually inspect the input connector for damage, foreign materials, or signs of moisture.
- Avoid inserting or removing the cable in a non-horizontal direction (for example, upward, downward, left, right, or forward direction). Keep it straight.

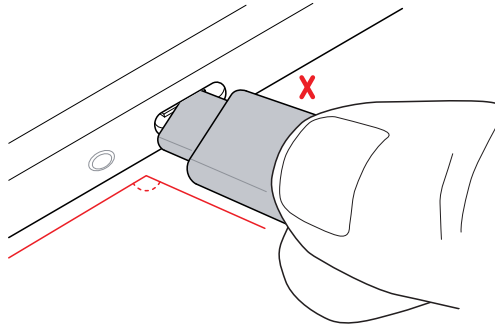

- Avoid inserting or removing the cable in a forceful manner.
- Avoid wiggling the cable when plugged into the port.
- Avoid pulling or tugging the cable when plugged into the port.

Connecting a USB-C Cable

It is important to correctly align the cable in a straight line when inserting it into the device to prevent damage to the connector or cable.

Examine the device's USB-C port and USB-C connector for damage. If either is damaged, stop using it and get it serviced or repaired.

1. Using your index finger and thumb, hold both sides of the USB-C cable.

2. Insert the cable straight into the port and not at an angle.

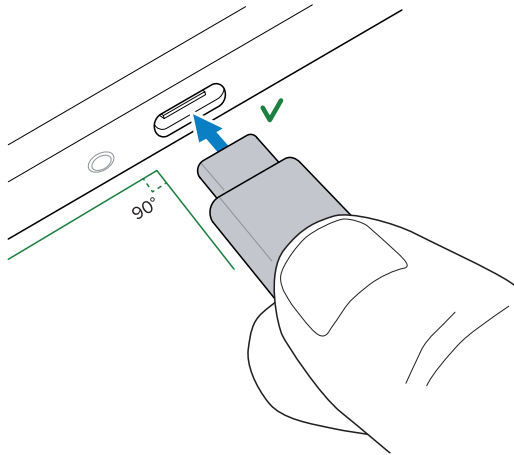

Disconnecting a USB-C Cable

It is important to correctly align the cable in a straight line when removing it from the device to prevent damage to the connector or cable.

Examine the device's USB-C port and USB-C connector for damage. If either is damaged, stop using it and get it serviced or repaired.

1. Using your index finger and thumb, hold both sides of the USB-C cable where it is connected to the device.
2. Gently pull it straight out and not at an angle.

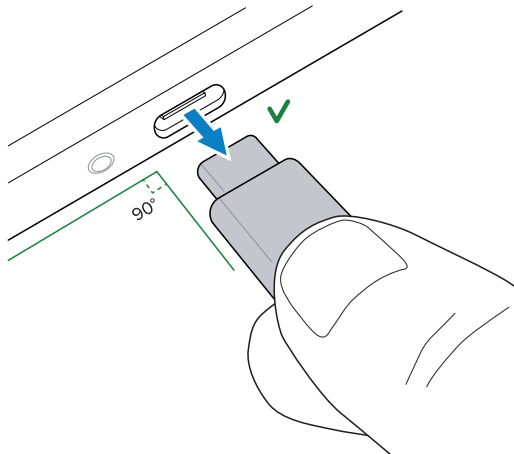

Cleaning Instructions

Use caution and avoid damaging the device when using cleaning materials.



CAUTION: Always wear eye protection. Read the warning label on alcohol product before using. If you have to use any other solution for medical reasons please contact the Global Customer Support Center for more information.



WARNING: Avoid exposing this product to contact with hot oil or other flammable liquids. If such exposure occurs, unplug the device and clean the product immediately in accordance with these guidelines.

Approved Cleanser Active Ingredients

100% of the active ingredients in any cleaner must consist of one or some combination of the following: isopropyl alcohol, bleach/sodium hypochlorite (see important note below), hydrogen peroxide, ammonium chloride, or mild dish soap.¹



IMPORTANT: Use pre-moistened wipes and do not allow liquid cleaner to pool.

Due to the powerful oxidizing nature of sodium hypochlorite, the metal surfaces on the device are prone to oxidation (corrosion) when exposed to this chemical in the liquid form (including wipes). In the event that these types of disinfectants come in contact with metal on the device, prompt removal with an alcohol-dampened cloth or cotton swab after the cleaning step is critical.

Approved cleaners include:

- Purell Ethanol Wipes
- 409 Glass Cleaner
- Windex Blue
- Diversey D10 Disinfectant (1% concentration)

Harmful Ingredients

The following chemicals are known to damage the plastics on the device and should not come in contact with the device: acetone; ketones; ethers; aromatic and chlorinated hydrocarbons; aqueous or alcoholic alkaline solutions; ethanolamine; toluene; trichloroethylene; benzene; carbolic acid and TB-lysoform.

Many vinyl gloves contain phthalate additives, which are often not recommended for medical use and are known to be harmful to the housing of the device.

Device Cleaning Instructions

Do not apply liquid directly to the device. Dampen a soft cloth or use pre-moistened wipes. Do not wrap the device in the cloth or wipe, instead gently wipe the unit. Be careful not to let liquid pool around the display window or other places. Before use, allow the unit to air dry.



NOTE: For thorough cleaning, it is recommended to first remove all accessory attachments, such as hand straps or cradle cups from the mobile device and to clean them separately.

Special Cleaning Notes

Do not handle the device while wearing vinyl gloves containing phthalates. Remove vinyl gloves and wash hands to eliminate any residue left from the gloves.

¹ When using sodium hypochlorite (bleach) based products, always follow the manufacturer's recommended instructions: use gloves during application and remove the residue afterward with a damp alcohol cloth or a cotton swab to avoid prolonged skin contact while handling the device.

If products containing any of the harmful ingredients listed above are used prior to handling the device, such as a hand sanitizer that contains ethanolamine, hands must be completely dry before handling the device to prevent damage to the device.



IMPORTANT: If the battery connectors are exposed to cleaning agents, thoroughly wipe off as much of the chemical as possible and clean with an alcohol wipe. It is also recommended to install the battery in the terminal prior to cleaning and disinfecting the device to help minimize buildup on the connectors. When using cleaning/disinfectant agents on the device, it is important to follow the directions prescribed by the cleaning/disinfectant agent manufacturer.

Cleaning Materials Required

- Alcohol wipes with 70% isopropyl alcohol
- Lens tissue
- Cotton-tipped applicators
- 70% Isopropyl alcohol
- Can of compressed air for electronics with a dispenser tube

Cleaning Frequency

The cleaning frequency is at the customer's discretion due to the varied environments in which the mobile devices are used and may be cleaned as frequently as required. When dirt is visible, it is recommended to clean the mobile device to avoid the build-up of particles, which makes the device more difficult to clean later on.

For consistency and optimum image capture, it is recommended to clean the camera window periodically especially when used in environments prone to dirt or dust.

Cleaning the Device

This section describes how to clean the housing, display, and camera for the device.

For more information on cleaning the device connector, refer to [Cleaning the Connectors](#).

Housing

Thoroughly wipe the housing, including all buttons and triggers, using an approved alcohol wipe.

Display

The display can be wiped down with an approved alcohol wipe, but care should be taken not to allow any pooling of liquid around the edges of the display. Immediately dry the display with a soft, non-abrasive cloth to prevent streaking.

Camera and Exit Window

Wipe the camera and exit the window periodically with lens tissue or other material suitable for cleaning optical material such as eyeglasses.

Cleaning Battery Connectors

1. Remove the main battery from the mobile computer.
2. Dip the cotton portion of the cotton-tipped applicator in isopropyl alcohol.
3. To remove any grease or dirt, rub the cotton portion of the cotton-tipped applicator back-and-forth across the connectors on the battery and terminal sides. Do not leave any cotton residue on the connectors.
4. Repeat at least three times.
5. Use a dry cotton-tipped applicator and repeat steps 3 and 4. Do not leave any cotton residue on the connectors.
6. Inspect the area for any grease or dirt and repeat the cleaning process if necessary.



CAUTION: After cleaning the battery connectors with bleach-based chemicals, follow the Battery Connector Cleaning instructions to remove bleach from the connectors.

Cleaning Cradle Connectors

1. Remove the DC power cable from the cradle.
2. Dip the cotton portion of the cotton-tipped applicator in isopropyl alcohol.
3. Rub the cotton portion of the cotton-tipped applicator along the pins of the connector. Slowly move the applicator back and forth from one side of the connector to the other. Do not leave any cotton residue on the connector.
4. All sides of the connector should also be rubbed with the cotton-tipped applicator.
5. Remove any lint left by the cotton-tipped applicator.
6. If grease and other dirt can be found on other areas of the cradle, use a lint-free cloth and alcohol to remove.
7. Allow at least 10 to 30 minutes (depending on ambient temperature and humidity) for the alcohol to air dry before applying power to cradle.

If the temperature is low and humidity is high, longer drying time is required. Warm temperature and low humidity requires less drying time.



CAUTION: After cleaning the cradle connectors with bleach-based chemicals, follow the Cleaning Cradle Connectors instructions to remove bleach from the connectors.

Troubleshooting

This section provides instructions for resetting the device and troubleshooting the device and cradles.

Resetting the Device

There are two reset functions, soft reset and hard reset.

Performing a Soft Reset

Perform a soft reset if applications stop responding.

1. Press and hold the Power button until the menu appears.
2. Touch **Restart**.
3. The device reboots.

Performing a Hard Reset



NOTE: Performing a hard reset with a microSD card installed in the device may cause damage or data corruption to the microSD card.

Perform a hard reset if the device stops responding.

1. Simultaneously press the Power and Volume Up buttons for at least four seconds.
2. When the screen turns off, release the buttons.
3. The device reboots.

Troubleshooting the Device

The following table provides typical problems that might arise and the solution for correcting the problem.

Table 30 Troubleshooting the Device

Problem	Cause	Solution
After installing the battery, the device does not boot up.	The power button was not pressed.	Press the Power button.
When pressing the power button, the device does not turn on.	The battery is not charged.	Charge or replace the battery in the device.
	The battery is not installed properly.	Install the battery properly.
	System crash.	Perform a reset.
When pressing the power button, the device does not turn on, but two LEDs blink.	Battery charge is at a level where data is maintained, but the battery should be recharged.	Charge or replace the battery in the device.
The battery did not charge.	Battery failed.	Replace battery. If the device still does not operate, perform a reset.
	The device was removed from the cradle while the battery was charging.	Insert the device in the cradle.

Table 30 Troubleshooting the Device (Continued)

Problem	Cause	Solution
	Extreme battery temperature.	The battery does not charge if the ambient temperature is below 5°C to 50°C (41°F to 122°F).
Cannot see characters on display.	The device is not powered on.	Press the Power button.
During data communication with a host computer, no data transmitted or transmitted data was incomplete.	The device is removed from the cradle or disconnected from the host computer during communication.	Replace the device in the cradle, or reattach the communication cable and re-transmit.
	Incorrect cable configuration.	See the system administrator.
	Communication software was incorrectly installed or configured.	Perform setup.
During data communication over Wi-Fi, no data transmitted or transmitted data was incomplete.	The Wi-Fi radio is not on.	Turn on the Wi-Fi radio.
	You moved out of range of an access point.	Move closer to an access point.
During data communication over Bluetooth, no data transmitted or transmitted data was incomplete.	The Bluetooth radio is not on.	Turn on the Bluetooth radio.
	You moved out of range of another Bluetooth device.	Move within 10 meters (32.8 feet) of the other device.
During data communication over mobile data, no data transmitted or transmitted data was incomplete.	Mobile data is not on.	Turn on mobile data. If it is already on, turn it off and on again.
	You moved out of the coverage area.	Move into a coverage area.
No sound.	The volume setting is low or turned off.	Adjust the volume.
The device shuts off.	The device is inactive.	The display turns off after a period of inactivity. Set this period to 15 seconds, 30 seconds, 1, 2, 5, 10 or 30 minutes.
	The battery is depleted.	Replace the battery.
Tapping the window buttons or icons does not activate the corresponding feature.	The device is not responding.	Reboot the device.

Table 30 Troubleshooting the Device (Continued)

Problem	Cause	Solution
A message appears stating that the device's memory is full.	Too many files are stored on the device.	Delete unused memos and records. Save these records on the host computer (or use an SD card for additional memory).
	Too many applications are installed on the device.	Remove user-installed applications on the device to recover memory. Select Settings > Apps > All Apps . Select the app in the list and select UNINSTALL .
The device does not decode with reading bar code.	The scanning application is not loaded.	Load a scanning application on the device or enable DataWedge. See the system administrator.
	Unreadable bar code.	Ensure the symbol is not defaced.
	The distance between the exit window and barcode is incorrect.	Place the device within the proper scanning range.
	The device is not programmed for the bar code.	Program the device to accept the type of bar code being scanned. Refer to the EMDK or DataWedge application.
	The device is not programmed to generate a beep.	If the device does not beep on a good decode, set the application to generate a beep on good decode.
	The battery is low.	Check the battery level if the scanner stops emitting a laser beam upon a trigger press. The scanner shuts off when the battery is low before the device's low battery condition notification. Note: If the scanner is still not reading symbols, contact the distributor or the Global Customer Support Center.
The device cannot find any Bluetooth devices nearby.	Too far from other Bluetooth devices.	Move closer to the other Bluetooth device(s), within a range of 10 meters (32.8 feet).
	The Bluetooth device(s) nearby is not turned on.	Turn on the Bluetooth device(s) to find.
	The Bluetooth device(s) are not in discoverable mode.	Set the Bluetooth device(s) to discoverable mode. If needed, refer to the device's user documentation for help.
Cannot unlock the device.	The user enters an incorrect password.	If the user enters an incorrect password five times, the user is requested to wait for 30 seconds when using a PIN, Pattern, or Password.
Multi-User mode is causing undefined behavior.	Multi-User mode is not supported by the Mobility DNA Enterprise License.	Perform a soft or hard reset on the device.

1-Slot Charge Only Cradle Troubleshooting

The following table provides troubleshooting information for the cradle.

Table 31 Troubleshooting the 1-Slot Charge Only Cradle

Symptom	Possible Cause	Action
The device battery is not charging.	The device was removed from the cradle, or the cradle was unplugged from AC power too soon.	Ensure the cradle is receiving power. Ensure the device is seated correctly. Confirm main battery is charging. The standard battery charges from fully depleted to 80% in less than 1 hour and 20 minutes. The extended battery charges from fully depleted to 80% in less than 1 hour and 50 minutes.
	The battery is faulty.	Verify that other batteries charge properly. If so, replace the faulty battery.
	The device is not fully seated in the cradle.	Remove and re-insert the device into the cradle, ensuring it is firmly seated.
	Extreme battery temperature.	The battery does not charge if the ambient temperature is below 5°C (41°F) or above 40°C (104°F).

1-Slot USB Cradle Troubleshooting

The following table provides troubleshooting information for the cradle.

Table 32 Troubleshooting the 1-Slot USB Cradle

Symptom	Possible Cause	Action
LEDs do not light when the device is inserted.	The cradle is not receiving power.	Ensure the power cable is connected securely to the cradle and AC power.
	The device is not seated firmly in the cradle.	Remove and re-insert the device into the cradle, ensuring it is firmly seated.
The device battery is not charging.	The device was removed from the cradle, or the cradle was unplugged from AC power too soon.	Ensure the cradle is receiving power. Ensure the device is seated correctly. Confirm main battery is charging. The standard battery charges from fully depleted to 80% in less than 1 hour and 20 minutes. The extended battery charges from fully depleted to 80% in less than 1 hour and 50 minutes.
	The battery is faulty.	Verify that other batteries charge properly. If so, replace the faulty battery.
	The device is not fully seated in the cradle.	Remove and re-insert the device into the cradle, ensuring it is firmly seated.
	Extreme battery temperature.	The battery does not charge if the ambient temperature is below 5°C (41°F) or above 40°C (104°F).

1-Slot Cradle with Spare Battery Slot

The following table provides troubleshooting information for the cradle.

Table 33 Troubleshooting the 1-Slot Cradle with Spare Battery Slot

Symptom	Possible Cause	Action
LEDs do not light when the device is inserted.	The cradle is not receiving power.	Ensure the power cable is connected securely to the cradle and AC power.
	The device is not seated firmly in the cradle.	Remove and re-insert the device into the cradle, ensuring it is firmly seated.
The device battery is not charging.	The device was removed from the cradle, or the cradle was unplugged from AC power too soon.	Ensure the cradle is receiving power. Ensure the device is seated correctly. Confirm main battery is charging. The standard battery charges from fully depleted to 80% in less than 1 hour and 20 minutes. The extended battery charges from fully depleted to 80% in less than 1 hour and 50 minutes.
	The battery is faulty.	Verify that other batteries charge properly. If so, replace the faulty battery.
	The device is not fully seated in the cradle.	Remove and re-insert the device into the cradle, ensuring it is firmly seated.
	Extreme battery temperature.	The battery does not charge if the ambient temperature is below 5°C (41°F) or above 40°C (104°F).
The spare battery is not charging.	The battery is not fully seated in the charging slot.	Remove and re-insert the spare battery in the cradle, ensuring it is firmly seated. The standard battery charges from fully depleted to 80% in less than 1 hour and 20 minutes. The extended battery charges from fully depleted to 80% in less than 1 hour and 50 minutes.
	The battery was inserted incorrectly.	Re-insert the battery so the charging contacts on the battery align with the contacts on the cradle.
	The battery is faulty.	Verify that other batteries charge properly. If so, replace the faulty battery.

5-Slot Charge Only Cradle Troubleshooting

The following table provides troubleshooting information for the 5-Slot Charge Only cradle.

Table 34 Troubleshooting the 5-Slot Charge Only Cradle

Problem	Cause	Solution
The battery is not charging.	The device was removed from the cradle too soon.	Replace the device in the cradle. The standard battery charges from fully depleted to 80% in less than 1 hour and 20 minutes. The extended battery charges from fully depleted to 80% in less than 1 hour and 50 minutes.
	The battery is faulty.	Verify that other batteries charge properly. If so, replace the faulty battery.

Table 34 Troubleshooting the 5-Slot Charge Only Cradle (Continued)

Problem	Cause	Solution
	The device is not inserted correctly in the cradle.	Remove the device and reinsert it correctly. Verify charging is active. Open the Battery Manager app.
	The ambient temperature of the cradle is too warm.	Move the cradle to an area where the ambient temperature is between 5°C (41°F) and 40°C (104°F).

5-Slot Ethernet Cradle Troubleshooting

The following table provides troubleshooting information for the 5-Slot Ethernet cradle.

Table 35 Troubleshooting the 5-Slot Ethernet Cradle

Problem	Cause	Solution
During communication, no data was transmitted, or transmitted data was incomplete.	The device was removed from the cradle during communications.	Replace the device in the cradle and retransmit.
	Incorrect cable configuration.	Ensure the correct cable configuration.
	The device has no active connection.	An icon is visible in the status bar if a connection is currently active.
The battery is not charging.	The device was removed from the cradle too soon.	Replace the device in the cradle. The standard battery charges from fully depleted to 80% in less than 1 hour and 20 minutes. The extended battery charges from fully depleted to 80% in less than 1 hour and 50 minutes.
	The battery is faulty.	Verify that other batteries charge properly. If so, replace the faulty battery.
	The device is not inserted correctly in the cradle.	Remove the device and reinsert it correctly. Verify charging is active. Open the Battery Manager app.
	The ambient temperature of the cradle is too warm.	Move the cradle to an area where the ambient temperature is between 5°C (41°F) and 40°C (104°F).

4-Slot Battery Charger Troubleshooting

The following table provides troubleshooting information for the 4-Slot Battery Charger.

Table 36 Troubleshooting the 4-Slot Battery Charger

Problem	Cause	Solution
The spare Battery Charging LED does not light when the spare battery is inserted.	The spare battery is not correctly seated.	Remove and re-insert the spare battery into the charging slot, ensuring it is correctly seated.
The spare battery not charging.	The charger is not receiving power.	Ensure the power cable is connected securely to the charger and AC power.
	The spare battery is not correctly seated.	Remove and re-insert the battery into the battery adapter, ensuring it is correctly seated.
	The battery adapter is not seated properly.	Remove and re-insert the battery adapter into the charger, ensuring it is correctly seated.
	The battery was removed from the charger, or the charger was unplugged from AC power too soon.	Ensure the charger is receiving power. Ensure the spare battery is seated correctly. The standard and extended battery charges from fully depleted to 90% in less than 4 hours.
	The battery is faulty.	Verify that other batteries charge properly. If so, replace the faulty battery.
	The ambient temperature of the cradle is too warm.	Move the cradle to an area where the ambient temperature is between 5°C (41°F) and 40°C (104°F).

Technical Specifications

For device technical specifications, go to zebra.com/support.

SE4710 Decode Distances

The table lists the typical distances for selected barcode densities. The minimum element width (or “symbol density”) is the width in mils of the narrowest element (bar or space) in the symbol.

Table 37 SE4710 Decode Distances

Bar Code Type	Near Distance	Far Distance
	Typical	Typical
5 mil Code 39	2.4 in. 6.1 cm	9.5 in. 24.1 cm
5.0 mil Code 128	2.8 in. 7.1 cm	9.0 in. 22.9 cm
6.6 mil PDF417	2.4 in. 6.1 cm	8.0 in. 20.3 cm
10 mil Data Matrix	2.9 in. 7.49 cm	9.0 in. 22.9 cm
100% UPCA	1.8 in. 5.1 cm	19.5 in. 26.2 cm
15 mil QR Code	1.2 in. 4.6 cm	12 in. 30.5 cm
20 mil QR Code	1.2 in. 4.6 cm	14 in. 35.6 cm
20 mil Code 39	2.0 in. 5.1 cm	26.0 in. 66.0 cm

Table 37 SE4710 Decode Distances (Continued)

Bar Code Type	Near Distance	Far Distance
	Typical	Typical
*Limited by width of barcode in field of view.		
 NOTE: Photographic quality barcode at 15° tilt pitch angle under 30 fcd ambient illumination. Distances measured from the front edge of the scan engine chassis.		

SE55 Decode Distances

The table below lists the typical distances for selected bar code densities. The minimum element width (or “symbol density”) is the width in mils of the narrowest element (bar or space) in the symbol.

Table 38 SE55 Decode Distances

Symbol Density/ Bar Code Type	Typical Working Ranges	
	Near	Far
3 mil Code 39	6.9 (cm) / 2.7 (in.)	41.1 (cm) / 16.2 (in.)
5 mil Code 39	6.4 (cm) / 2.5 (in.)	67.6 (cm) / 26.6 (in.)
5 mil PDF417	7.1 (cm) / 2.8 (in.)	49.8 (cm) / 19.6 (in.)
6.67 mil PDF417	6.6 (cm) / 2.6 (in.)	65.0 (cm) / 25.6 (in.)
10 mil DataMatrix	5.6 (cm) / 2.2 (in.)	68.8 (cm) / 27.1 (in.)
80% UPC	5.1 (cm) / 2.0 (in.)	141.0 (cm) / 55.5 (in.)
100% UPC (13 mil)	6.4 (cm) / 2.5 (in.)	180.3 (cm) / 71.0 (in.)
15 mil Code 128 (4 in. wide)	18.3 (cm) / 7.2 (in.)	182.9 (cm) / 72.0 (in.)
20 mil Code 39	*	276.9 (cm) / 109.0 (in.)
55 mil Code 39	*	744.2 (cm) / 293.0 (in.)
100 mil Code 39	*	1,407 (cm) / 554.0 (in.)
100 mil DataMatrix	*	685.5 (cm) / 270.0 (in.)
Note: *Limited by the width of barcode in field of view; refer to SE55 Integration Guide for details. The photographic quality barcode at 18° tilt pitch angle under 20 fcd ambient illumination. Measurement is taken straight from the face of the scan engine's exit window to the surface of the barcode.		

1-Slot Charge Only Cradle Specifications

The following table provides technical specifications for the 1-Slot Charge Only cradle.

Table 39 1-Slot Charge Only Cradle Technical Specifications

Item	Description
Dimensions	Height: 11.5 cm (4.5 in.) Width: 11.3 cm (4.4 in.) Depth: 15 cm (5.9 in.)
Weight	306 g (10.8 oz.)
Input Voltage	5 VDC
Power Consumption	up to 12.5 watts
Operating Temperature	5°C to 40°C (41°F to 104°F)
Storage Temperature	-40°C to 70°C (-40°F to 158°F)
Charging Temperature	5°C to 40°C (41°F to 104°F)
Humidity	5% to 95% non-condensing
Drop	76.2 cm (30.0 in.) drops to vinyl tiled concrete at room temperature.
Electrostatic Discharge (ESD)	+/- 15 kV air +/- 8 kV contact +/- 8 kV indirect discharge

1-Slot USB Cradle Specifications

The following table provides technical specifications for the 1-Slot USB cradle.

Table 40 1-Slot USB Cradle Technical Specifications

Item	Description
Dimensions	Height: 9.5 cm (3.7 in.) Width: 10 cm (3.9 in.) Depth: 13.5 cm (5.3 in.)
Weight	412.4 g (14.5 oz.)
Input Voltage	12 VDC
Power Consumption	up to 50 watts
Operating Temperature	5°C to 40°C (41°F to 104°F)
Storage Temperature	-40°C to 70°C (-40°F to 158°F)
Charging Temperature	5°C to 40°C (41°F to 104°F)
Humidity	5% to 95% non-condensing
Drop	76.2 cm (30.0 in.) drops to vinyl tiled concrete at room temperature.

Table 40 1-Slot USB Cradle Technical Specifications (Continued)

Item	Description
Electrostatic Discharge (ESD)	+/- 20 kV air +/- 10 kV contact +/- 10 kV indirect discharge

1-Slot Charge Only with Battery Cradle Specifications

The following table provides technical specifications for the 1-Slot Charge Only with Battery cradle.

Table 41 1-Slot Charger Only with Battery Cradle Technical Specifications

Item	Description
Dimensions	Height: 10.0 cm (3.9 in.) Width: 13.5 cm (5.3 in.) Depth: 19.7 cm (7.8 in.)
Weight	826 g (29.1 oz.)
Input Voltage	12 VDC
Power Consumption	Up to 50 W
Operating Temperature	5°C to 40°C (41°F to 104°F)
Storage Temperature	-40°C to 70°C (-40°F to 158°F)
Charging Temperature	5°C to 40°C (41°F to 104°F)
Humidity	5% to 95% non-condensing
Drop	76.2 cm (30.0 in.) drops to vinyl tiled concrete at room temperature.
Electrostatic Discharge (ESD)	+/- 20 kV air +/- 10 kV contact +/- 10 kV indirect discharge

5-Slot Charge Only Cradle Specifications

The following table provides technical specifications for the 5-Slot Charge Only cradle.

Table 42 5-Slot Charge Only Cradle Technical Specifications

Item	Description
Dimensions	Height: 10.2 cm (4.0 in.) Width: 13.1 cm (5.2 in.) Depth: 48.9 cm (19.3 in.)
Weight	1,968 g (69.4 oz.)

Table 42 5-Slot Charge Only Cradle Technical Specifications (Continued)

Item	Description
Input Voltage	12 VDC
Power Consumption	up to 108 watts
Operating Temperature	5°C to 40°C (41°F to 104°F)
Storage Temperature	-40°C to 70°C (-40°F to 158°F)
Charging Temperature	5°C to 40°C (41°F to 104°F)
Humidity	5% to 95% non-condensing
Drop	76.2 cm (30.0 in.) drops to vinyl tiled concrete at room temperature.
Electrostatic Discharge (ESD)	+/- 20 kV air +/- 10 kV contact +/- 10 kV indirect discharge

5-Slot Ethernet Cradle Specifications

The following table provides technical specifications for the 1-Slot Ethernet cradle.

Table 43 5-Slot Ethernet Cradle Technical Specifications

Item	Description
Dimensions	Height: 9.5 cm (3.7 in.) Width: 13.5 cm (5.3 in.) Depth: 49 cm (19.3 in.)
Weight	2,107 g (74.3 oz.)
Input Voltage	12 VDC
Power Consumption	up to 108 watts
Operating Temperature	5°C to 40°C (41°F to 104°F)
Storage Temperature	-40°C to 70°C (-40°F to 158°F)
Charging Temperature	5°C to 40°C (41°F to 104°F)
Humidity	5% to 95% non-condensing
Drop	76.2 cm (30.0 in.) drops to vinyl tiled concrete at room temperature.
Electrostatic Discharge (ESD)	+/- 20 kV air +/- 10 kV contact +/- 10 kV indirect discharge

4-Slot Battery Charger Specifications

The following table provides technical specifications for the 4-Slot Battery Charger.

Table 44 4-Slot Battery Charger Technical Specifications

Item	Description
Dimensions	Height: 10.2 cm (4.0 in.) Width: 9.7 cm (3.8 in.) Depth: 13.2 cm (5.2 in.)
Weight	512 g (18.0 oz.)
Input Voltage	12 VDC
Power Consumption	up to 50 watts
Operating Temperature	5°C to 40°C (41°F to 104°F)
Storage Temperature	-40°C to 70°C (-40°F to 158°F)
Charging Temperature	5°C to 40°C (41°F to 104°F)
Humidity	5% to 95% non-condensing
Drop	76.2 cm (30.0 in.) drops to vinyl tiled concrete at room temperature.
Electrostatic Discharge (ESD)	+/- 20 kV air +/- 10 kV contact +/- 10 kV indirect discharge

Trigger Handle Specifications

The following table provides technical specifications for the Trigger Handle.

Table 45 Trigger Handle Technical Specifications

Item	Description
Dimensions	Height: 15 cm (5.9 in.) Width: 10 cm (3.9 in.) Depth: 19 cm (7.5 in.)
Weight	240 g (8.5 oz.)
Operating Temperature	-10°C to 50°C (14°F to 122°F)
Storage Temperature	-40°C to 70°C (-40°F to 158°F)
Humidity	5% to 95% non-condensing
Drop	1.5 m (5 ft) drop to concrete over the operating temperature.
tatic Discharge (ESD)	+/- 20 kV air +/- 10 kV contact +/- 10 kV indirect discharge

